

TOP DEAL

KSTOOLS

WWW.KSTOOLS.COM

No Limits!

NAŠA KLÚČOVÁ KOMPETENCIA:

KVALITA ZA SKVELÚ CENU!

EVOLUTION
SERIES

NOVINKA



Kompletný kusovník

917.0255

1/4" + 3/8" + 1/2" + 5/16"

255 DIELOV
LEN

119,90



Ďalšie informácie

P₁₀

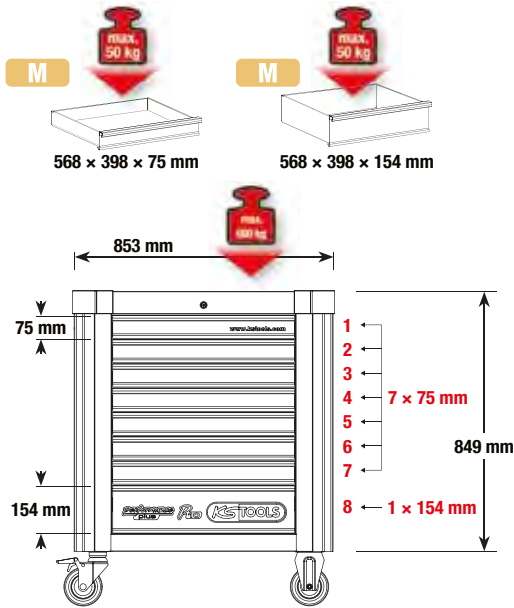

Integrovaná ochrana hrán

VYBERTE SI SVOJ POWER BALÍK

810.7397



Ďalšie informácie



P₁₅

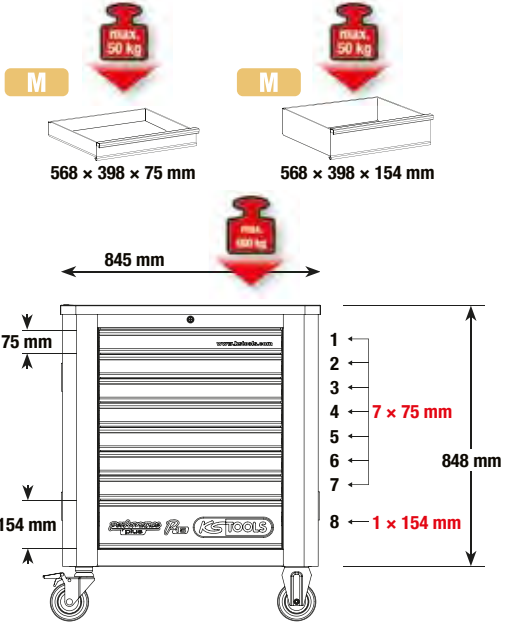

815.7397

PERFEKTNÝ BALÍK S 397 DIEĽMI

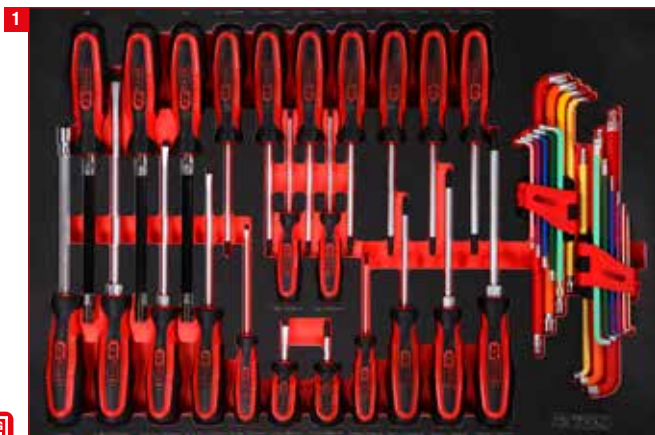

1
41 Súprava kliešti a skrutkovačov

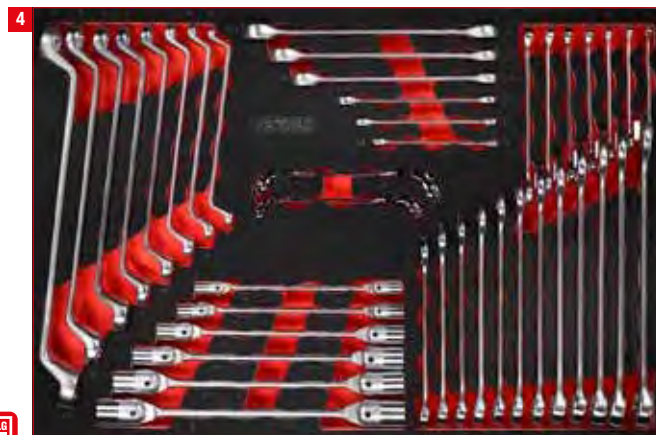

4
41 Súprava skrutkových kľúčov

2699,00

810.7397 Dielenský vozík P10 so 397 kusmi náradia



2
111 1/4" + 3/8" + 1/2" súprava nástrčkových kľúčov

2799,00

815.7397 Dielenský vozík P15 so 397 kusmi náradia



5
28 Súprava kliešti a pilníkov



6
43 Súprava na výmenu oleja a servis pneumatík



3
111 Súprava nástrčných orechov s bitmi 1/2"



7
22 Súprava kladív a sekáčov

VITAJTE V KRÁĽOVSKEJ



Ďalšie informácie



3799,00



Integrovaná ochrana hrán



S držiakom na dýzy



Stabilné guľôčkové ložiská



Antistatické kolieska s brzdou



Uzamykateľná zámka

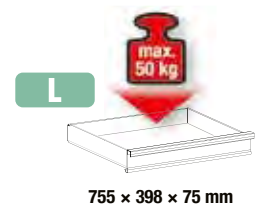
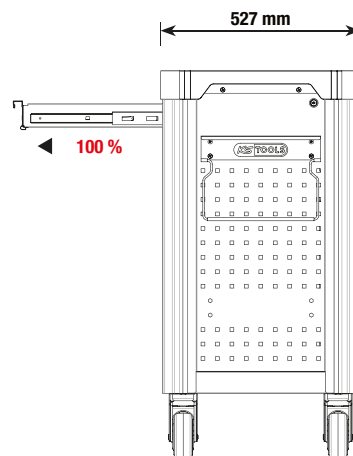
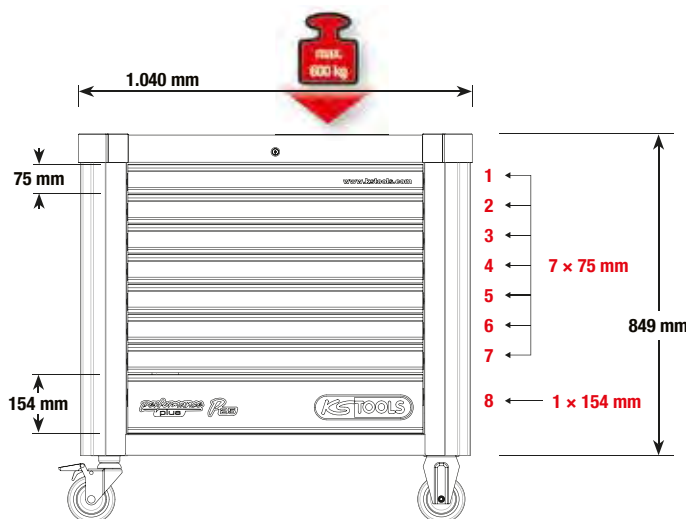

755 x 398 x 75 mm

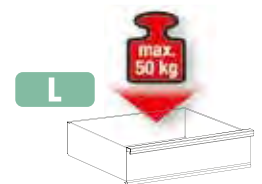

755 x 398 x 154 mm

825.8564



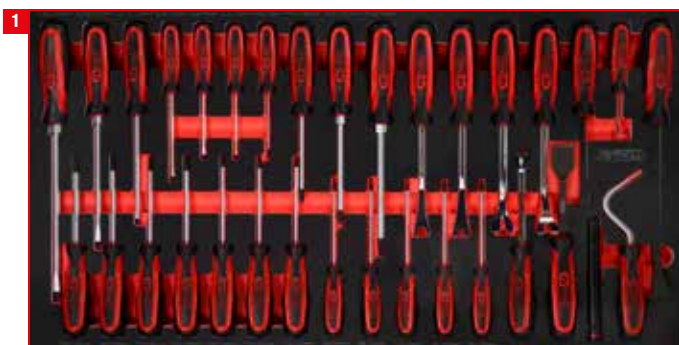

Súprava klieští a skrutkovačov

33



1/4" + 3/8" súprava nástrčkových kľúčov

213



1/2" súprava nástrčkových kľúčov

86

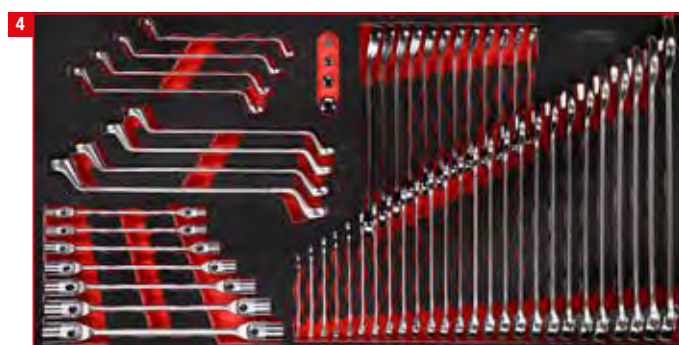

Súprava skrutkových kľúčov

57



Súprava skrutkových kľúčov

54

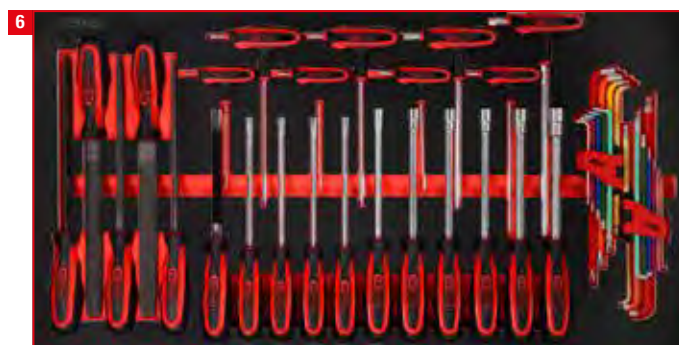

Súprava skrutkovačov a pilníkov

42

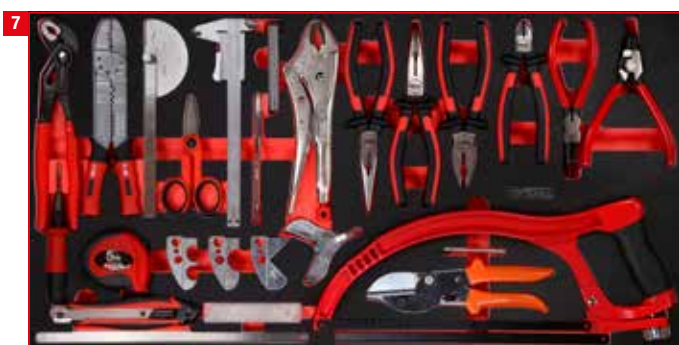

Súprava klieští a meracieho náradia

39



Súprava kladív, sekáčov a silových nástrčných kľúčov

40

KOLKO VOZÍKOV SI ŽELÁTE?



pracovná doska s penovou vložkou s hrúbkou 10 mm



uzamykateľný cez zabudovanú vložku zámku



so samočinným vtáhováním a funkciou SOFT-CLOSE



Štvorcové dierovanie pre diely príslušenstva



2 x s pohyblivou a otočnou brzdou, kolesá : Ø 125 mm

ECO Line

449,90

BEZ NÁRADIA



i **1** 897.0007
Ďalšie informácie

Technické údaje:	Eco Line 897.0007	Racing Line 826.0007
Celková nosnosť:	300,0 kg	350,0 kg
Zaťažiteľnosť pre zásuvku:	25,0 kg	30,0 kg
samočinným vtáhováním a funkciou SOFT-CLOSE:	✓	✗
Priemer kolesa:	125,0 mm	125,0 mm
Zaistovač kolies:	✓	✓
S centrálnym zamykaním:	✓	✓
samostatné zaistenie:	✗	✓
Výška:	1014,0 mm	976,0 mm
Šírka:	748 mm	788 mm
Hĺbka:	459,0 mm	496,0 mm
Vnúť. rozmer zásuvky:	565 x 395 mm	565 x 395 mm
s polyuretánovou ochranou hrán a rohov:	✗	✓
Štvorcové dierovanie pre diely príslušenstva:	✓	✓
Počet zásuviek:	7	7
hrúbka plechu:	0,8 mm	0,9 mm
uchopovacia lišta:	✓	✓
Vytáhovanie zásuvky:	100 %	90 %
pracovná doska s priehradkami na drobné súčiastky:	✗	✓
Pracovná doska s penovými vložkami:	✓	✗
vedenie zásuvky s guľôčkovými ložiskami:	✓	✓
s bočnou kovovou rukoväťou:	✓	✓

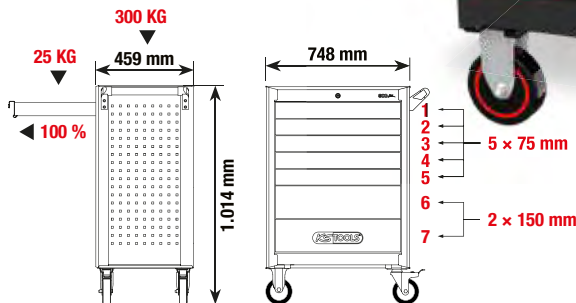

NEVIETE SA ROZHODNÚŤ? ZVOĽTE KVALITU!

RACING Line



pracovná doska z ABS s priehradkami na drobné diely



uzamykateľný cez zabudovanú vložku zámku



samostatné zaistenie zabraňuje neželanému otvoreniu



Štvorcové dierovanie pre diely príslušenstva



2 x s pohyblivou a otočnou brzdou, kolesá : Ø 125 mm

499,90

BEZ NÁRADIA

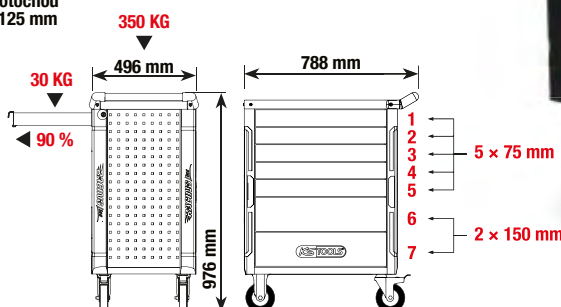

i **1** 826.0007
Ďalšie informácie

ECO *line*

So 7 zásuvkami a
215 dielnou sadou
prémiového náradia

679,⁹⁰

897.7215



**ŠTARTOVACÍ
BALÍK - 215 KS.**

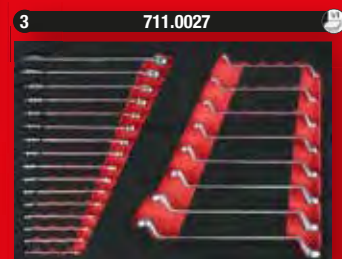

Ďalšie informácie

RACING *line*

So 7 zásuvkami a
215 dielnou sadou
prémiového náradia

699,⁹⁰

826.7215



UNIVERZÁLNY BALÍK - 515 KS.

ECO *line*

So 7 zásuvkami a
515 dielnou sadou
prémiového náradia

879,⁹⁰

897.7515

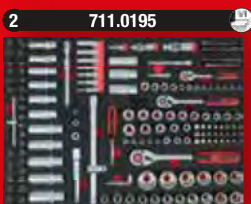
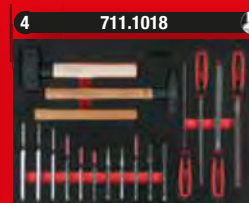
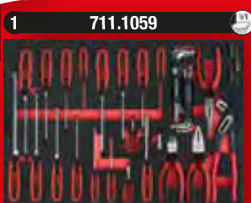

Ďalšie informácie

RACING *line*

So 7 zásuvkami a
515 dielnou sadou
prémiového náradia

899,⁹⁰

826.7515



ECO *line*

So 7 zásuvkami a
598 dielnou sadou
prémiového náradia

1299,⁰⁰

897.7598

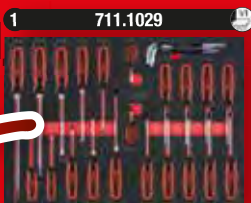

**POWER BALÍK -
598 KS.**

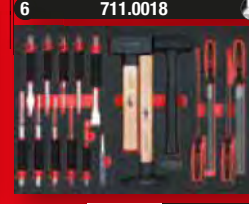
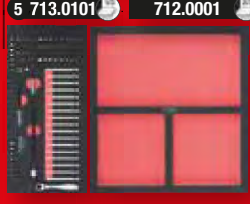

Ďalšie informácie

RACING *line*

So 7 zásuvkami a
598 dielnou sadou
prémiového náradia

1349,⁰⁰

826.7598



- DIN 3110 / ISO 1085 / ISO 10102 / ISO 3318
- Otvor zahnutý 15°
- brúsené hlavy
- matne satinovaný
- chróm vanád

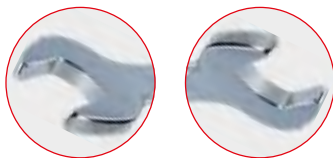

od **19,90**

A	517.0148			6x7 · 8x9 · 10x11 · 12x13 14x15 · 16x17 · 18x19 20x22 mm	19,90 €
B	517.0123			6x7 · 8x9 · 10x11 · 12x13 14x15 · 16x17 · 18x19 20x22 · 21x23 · 24x27 30x32 mm	44,90 €
C	517.0125			6x7 · 8x9 · 10x11 · 12x13 14x15 · 16x17 · 18x19 20x22 · 21x23 · 24x27 25x28 · 30x32 mm	49,90 €



- profil FlankTraction
- Otvor zahnutý 15°
- Prstenec zahnutý 15°
- leštené hlavy
- matne satinovaný



od **22,90**

A	517.0048			8 · 9 · 10 · 11 · 13 · 14 17 · 19 mm	22,90 €
B	517.0052			8 · 9 · 10 · 11 · 12 · 13 · 14 15 · 16 · 17 · 18 · 19 mm	42,90 €
C	517.0043			6 · 7 · 8 · 9 · 10 · 11 · 12 13 · 14 · 15 · 16 · 17 · 18 19 · 20 · 21 · 22 · 24 · 27 30 · 32 mm	109,50 €



- 12-hran
- DIN 838 / ISO 1085 / ISO 10104 / ISO 3318
- očká zahnuté o 75°
- tenkostenné
- leštené hlavy



od **24,90**

A	517.0248			6x7 · 8x9 · 10x11 · 12x13 14x15 · 16x17 · 18x19 20x22 mm	24,90 €
B	517.0222			6x7 · 8x9 · 10x11 · 12x13 14x15 · 16x17 · 18x19 20x22 · 21x23 · 24x27 30x32 mm	49,90 €



i **1**
 Ďalšie informácie

14,90

315 mm

L R

22 mm

19 mm

522.1922

i **1**
 Ďalšie informácie

**OBOJSTRANNÁ
 RAČŇA 4V1**

10 mm

13 mm

17 mm

19 mm

19,90

72 \times 5°

L R

503.4565 10 x 13 x 17 x 19 mm

i **1**
 Ďalšie informácie

MULTITALENT

Multifunkčný kľúč

260 mm

8 - 17 mm

14 - 32 mm

14-32 mm

www.kstools.com

KSTOOLS 144.0055

8 - 9 - 10 - 11 - 12 - 13 - 14 - 15 - 16 - 17 - 18 - 19 - 20 - 21 - 22 - 23 - 24 - 25 - 26 - 27 - 28 - 29 - 30 - 31 - 32 mm

33,90

114.0055

i **12**
 Ďalšie informácie

72 \times 5°

L R

119,90

503.4665 8 - 9 - 10 - 11 - 12 - 13 - 14 - 15 - 16 - 17 - 18 - 19 mm

i **30**
 Ďalšie informácie

UNIVERZÁLNY

STOP

L R

5/16" x 13 mm

1/2"

10 mm x 13 mm

3/8"

1/4" x 10 mm

1/4"

12 x

12 x

168,90

503.4960 8 - 9 - 10 - 11 - 12 - 13 - 14 - 15 - 16 - 17 - 18 - 19 mm

i **2**
 Ďalšie informácie

72 5°

1/2" 305 - 445 mm

1/4" 173 - 223 mm

NOVINKA

**NASTAVITELNÉ:
 1/4" V 4 KROKOCH
 1/2" V 6 KROKOCH**

34,90

914.1412

i **1**
 Ďalšie informácie

NOVINKA

600 MM!

72 5°

1/2" 460 - 600 mm

stupeň: 1 2 3 4 5 6

24,90

NASTAVITELNÉ V 6 STUPŇOCH

914.1205

i **1**
 Ďalšie informácie

49,90

760 mm

**MAXIMÁLNA FLEXIBILITA,
 OPTIMÁLNE OVLÁDANIE**

1/2"

918.1293

72 5°

**STÁLÝ VÝKON -
 INOVATÍVNA FUNKCIA**

A B C

1/4" 3/8" 1/2"

od 24,90

			Nm			
A	920.1490		1/4"	102	140 mm	24,90 €
B	920.3890		3/8"	325	190 mm	29,90 €
C	920.1290		1/2"	710	245 mm	36,50 €

102 Nm

710 Nm

72 5°

54,90

920.0002

i **2**
 Ďalšie informácie

TO NAJLEPŠIE, ČO SME KEDY VYROBILI!

Vieme, čo dokážeme. A pretože presne vieme, aký dobrý je náš nový rad Monster rační, je samozrejmé, že vám na každý model poskytujeme záruku. Nie na 2 alebo 3 roky. Nie, až na 10 rokov! Aby bola záruka rovnako prémiová ako naše Monster račle!



1 80° 4.5° **29,90** **1/4"** **1**

 Ďalšie informácie

935.1490 **>110 Nm** 1/4" 106 g 125 mm

2 80° 4.5° **29,90** **1/4"** **1**

 Ďalšie informácie

935.1495 **>100 Nm** 1/4" 106 g 125 mm

3 96° 3.75° **39,90** **3/8"** **1**

 Ďalšie informácie

935.3890 **>365 Nm** 3/8" 227 g 199 mm



**ZARUČENÉ:
6 MONSTER
RAČNÍ PRE ŽIVOT!**

4 100° 3.6° **49,90** **1/2"** **1**

 Ďalšie informácie

935.1290 **>950 Nm** 1/2" 567 g 275 mm

5 100° 3.6° **69,90** **1/2"** **1**

 Ďalšie informácie

935.1295 **>950 Nm** 1/2" 757 g 425 mm

6 100° 3.6° **99,90** **1/2"** **1**

TELESKOPICKY VYSÚVATELNÉ
 Ďalšie informácie

935.1285 **>950 Nm** 1/2" 1.280 g 406 - 635 mm

406 431 457 482 508 533 557 582 607 635 mm

NOVINKA **-15%**

935.0002 **>950 Nm** **100° 3.6°** **1/2"** **+** **80° 4.5°** **1/4"** **>110 Nm** **1**

 Ďalšie informácie

69,90



Súprava nástrčných bitov pre imbusové skrutky, krátke

3/8"

4 mm 5 mm 6 mm 7 mm 8 mm 9 mm 10 mm 12 mm 14 mm



917.4000 4 - 5 - 6 - 7 - 8 - 9 - 10 - 12 - 14 mm



NOVINKA

34,90

JEDEN BIT, PROSÍM. ALE KRÁTKY!



Súprava nástrčných bitov pre skrutky Torx, krátke

3/8"

T10 T15 T20 T25 T27 T30 T40 T45 T50 T55



917.4015 T10 - T15 - T20 - T25 - T27 - T30 - T40 - T45 - T50 - T55

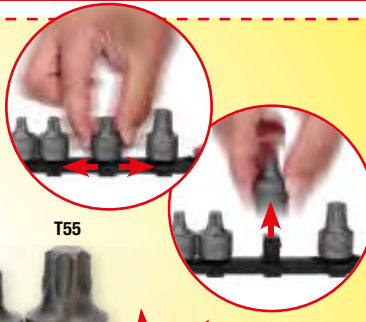

NOVINKA

39,90

TORX TOTAL: VŠETKO V JEDNOM KUFRI



Ďalšie informácie

5 x		1/4": E4 - E5 - E6 - E7 - E8
4 x		3/8": E10 - E12 - E14 - E16
4 x		1/2": E18 - E20 - E22 - E24
5 x		1/4": EPL4 - EPL5 - EPL6 - EPL7 - EPL8
4 x		3/8": EPL10 - EPL12 - EPL14 - EPL16
4 x		1/2": EPL18 - EPL20 - EPL22 - EPL24
8 x		1/4": T6 - T8 - T10 - T15 - T20 - T25 - T27 - T30
5 x		3/8": T40 - T45 - T47 - T50 - T55
2 x		1/2": T60 - T70
7 x		1/4": TB8 - TB10 - TB15 - TB20 - TB25 - TB27 - TB30
4 x		3/8": TB40 - TB45 - T50 - T55
1 x		1/2": TB60
7 x		1/4": IP8 - IP10 - IP15 - IP20 - IP25 - IP27 - IP30
3 x		3/8": IP40 - IP45 - IP50
2 x		1/2": IP55 - IP60
7 x		1/4": IPR8 - IPR10 - IPR15 - IPR20 - IPR25 - IPR27 - IPR30
3 x		3/8": IPR40 - IPR45 - IPR50
2 x		1/2": IPR55 - IPR60

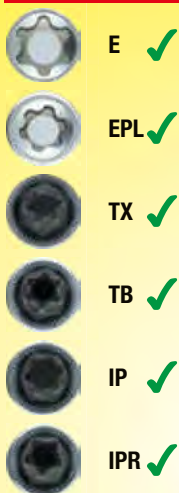

99,90

NOVINKA



EVOLUTION SERIES

1/4" + 3/8" + 1/2"



i  **30**
 Další informace

EVOLUTION SERIES

NOVINKA

79,90

1/2"

911.4510

STAINLESS STEEL

55 mm	●	5 - 6 - 7 - 8 - 10 - 12 - 14 - 17 - 19 mm
100 mm	●	5 - 6 - 7 - 8 - 10 - 11 - 12 - 13 mm
140 mm	●	5 - 6 - 7 - 8 - 10 - 12 - 14 mm
200 mm	●	5 - 6 - 7 - 8 - 10 - 12 mm

i  **32**
 Další informace

EVOLUTION SERIES

NOVINKA

79,90

1/2"

911.4520

STAINLESS STEEL

55 mm	★	M5 - M6 - M7 - M8 - M9 - M10 - M12 - M13 - M14
100 mm	★	M5 - M6 - M7 - M8 - M9 - M10 - M12 - M13 - M14
140 mm	★	M7 - M8 - M9 - M10 - M12 - M13 - M14
200 mm	★	M7 - M8 - M9 - M10 - M12 - M13 - M14

i  **26**
 Další informace

EVOLUTION SERIES

NOVINKA

79,90

1/2"

911.4540

STAINLESS STEEL

55 mm	●	M5 - M6 - M8 - M9 - M10 - M12 - M14 - M16
100 mm	●	M5 - M6 - M8 - M9 - M10 - M12 - M14
140 mm	●	M5 - M6 - M8 - M9 - M10 - M12 - M14
200 mm	●	M8 - M10 - M12 - M14

i  **32**
 Další informace

EVOLUTION SERIES

NOVINKA

79,90

1/2"

911.4550

STAINLESS STEEL

55 mm	★	T20 - T25 - T27 - T30 - T40 - T45 - T50 - T55 - T60 - T70
100 mm	★	T20 - T25 - T27 - T30 - T40 - T45 - T50 - T55 - T60 - T70
140 mm	★	T40 - T45 - T50 - T55 - T60 - T70
200 mm	★	T40 - T45 - T50 - T55 - T60 - T70

A matné satinovanie **B** vysoký lesk pochromovaný

od **27,90**

poniklovaný

A	917.0648		48	27,90 €	1/4"	
B	918.0648		48	29,90 €		4 - 4,5 - 5 - 5,5 - 6 - 7 - 8 - 9 10 - 11 - 12 - 13 - 14 mm

i **20**
Ďalšie informácie

8°

45

R

L

matné satinovanie

59,90

1/2"

10 - 11 - 12 - 13 - 14 - 15 - 16
17 - 18 - 19 - 20 - 21 - 22 - 24
27 - 30 - 32 mm

911.0620

A matné satinovanie **B** vysoký lesk pochromovaný

od **79,90**

poniklovaný

A	911.0694		94	79,90 €	1/4" + 1/2"	
B	918.0694		94	89,90 €		4 - 4,5 - 5 - 5,5 - 6 - 7 - 8 - 9 10 - 11 - 12 - 13 - 14 - 15 - 16 17 - 18 - 19 - 20 - 21 - 22 - 23 24 - 27 - 30 - 32 mm

i **108**
Ďalšie informácie

8°

45

R

L

matné satinovanie

89,90

1/4" + 1/2"

4 - 4,5 - 5 - 5,5 - 6 - 7 - 8 - 9
 10 - 11 - 12 - 13 - 14 - 15 - 16
 17 - 18 - 19 - 20 - 21 - 22 - 24
 27 - 30 - 32 mm

poniklovaný

911.0708



Ďalšie informácie

1/4"	4 - 4,5 - 5 - 5,5 - 6 - 7 - 8 - 9 - 10 - 11 - 12 13 - 14 mm
1/4"	4 - 5 - 6 - 7 - 8 - 9 - 10 mm
	E4 - E5 - E6 - E7 - E8
	⊖ ⊕ ⊗ ⊙ ⊛ ⊜ ⊝
3/8"	10 - 11 - 12 - 13 - 14 - 15 - 16 - 17 - 18 19 mm
3/8"	10 - 11 - 12 - 13 - 14 - 15 mm
	E10 - E11 - E12 - E14 - E16 - E1
1/2"	10 - 11 - 12 - 13 - 14 - 15 - 16 - 17 - 18 19 - 20 - 21 - 22 - 24 - 27 - 30 - 32 mm
1/2"	16 - 17 - 18 - 19 - 22 mm
	E20 - E24
1/4"	⊖ ⊕ ⊗ ⊙ ⊛ ⊜ ⊝
5/16"	⊖ ⊕ ⊗ ⊙ ⊛ ⊜ ⊝
1/4" - 3/8"	50 - 100 - 125 - 150 - 250 mm
1/2"	1,3 - 1,5 - 2 - 2,5 - 3 - 4 - 5 mm
1/4" - 3/8"	
1/2"	
1/4" - 3/8"	1/4" - 5/16"
1/4"	

1/4" + 3/8" + 1/2"

poniklovaný

matné satinovaný



94,90

1/4"	4 - 4,5 - 5 - 5,5 - 6 - 7 - 8 - 9 - 10 - 11 12 - 13 - 14 mm
1/4"	6 - 7 - 8 - 9 - 10 - 11 - 12 - 13 - 14 15 mm
	⊖ ⊕ ⊗ ⊙ ⊛ ⊜ ⊝
3/8"	10 - 11 - 12 - 13 - 14 - 15 - 16 - 17 - 18 19 mm
3/8"	10 - 11 - 12 - 13 - 14 - 15 mm
1/2"	10 - 11 - 12 - 13 - 14 - 15 - 17 - 18 - 19 20 - 21 - 22 - 24 - 27 - 30 - 32 mm
1/2"	17 - 19 - 22 mm
	⊛
1/4"	⊖ ⊕ ⊗ ⊙ ⊛ ⊜ ⊝
5/16"	⊖ ⊕ ⊗ ⊙ ⊛ ⊜ ⊝
12 x	8 - 9 - 10 - 11 - 12 - 13 - 14 - 15 - 16 17 - 18 - 19 mm
	1,3 - 1,5 - 2 - 2,5 - 3 - 4 - 5 mm
1/4" - 3/8"	
1/2"	
1/4"	



od 174,90

A matné satinovanie

B vysoký lesk pochromovaný

A 917.0216 216 174,90 €

B 918.0216 216 189,90 €

1/4" + 3/8" + 1/2"

A	911.0721				19 · 21 · 22 · 23 · 24 · 26 · 27 · 29 · 30 32 · 35 · 36 · 38 · 41 · 46 · 50 mm	219, ⁹⁰ €
B	911.0722				19 · 21 · 22 · 23 · 24 · 26 · 27 · 29 · 30 32 · 35 · 36 · 38 · 41 · 46 · 50 mm	248, ⁵⁰ €
C	911.0751				3/4" · 13/16" · 7/8" · 15/16" · 1" 1.1/16" · 1.1/8" · 1.3/16" · 1.1/4" 1.5/16 · 1.3/8" · 1.7/16" · 1.1/2" 1.5/8" · 1.3/4" · 2"	248, ⁵⁰ €

i **82**
Ďalšie informácie

1/4"			4 - 4,5 - 5 - 5,5 - 6 - 7 - 8 - 9 - 10 - 11 12 - 13 - 14 mm
1/2"			14 - 15 - 16 - 17 - 18 - 19 - 20 - 21 - 22 24 - 27 - 30 - 32 mm
1/4"			16 - 21 mm
1/4"			
5/16"			
1/4"			
1/2"			
1/4"			150 mm
1/4"			50 - 100 - 125 - 250 mm
1/2"			
1/4"			150 mm
12 x			8 - 10 - 11 - 12 - 13 - 14 - 17 - 19 - 22 mm

129,⁹⁰

matne satinovaný poniklovaný

i  **47**
Ďalšie informácie



1/2"		10 - 11 - 12 - 13 - 14 - 15 - 16 - 17 18 - 19 - 20 - 21 - 22 - 24 mm
3 x		16 - 18 - 21 mm
14 x		6 - 7 - 8 - 9 - 10 - 11 - 12 - 13 - 14 15 - 16 - 17 - 18 - 19 mm
1 x		250 mm
2 x		125 - 250 mm
1 x		1/2"
5 x		3 - 5,5 - 8 mm PH1 - PH2
1 x		T8 - T10 - T15 - T20 - T25 - T27 T30 - T40
1 x		2,5 - 3 - 4 - 5 - 6 - 7 - 8 - 10 mm
1 x		3 - 48 V
1 x		240 mm
1 x		180 mm
1 x		300 g















matné
satinovaný

149,90

1/2"

940.0047



1/4"		4 - 4,5 - 5 - 5,5 - 6 - 7 - 8 - 9 - 10 11 - 12 - 13 mm
1/2"		10 - 11 - 12 - 13 - 14 - 15 - 16 - 17 19 - 20 - 21 - 22 - 24 - 27 - 30 - 32 mm
12 x		8 - 9 - 10 - 11 - 12 - 13 - 14 - 15 - 16 17 - 18 - 19 mm
2 x		1/4": 100 mm / 1/2": 125 mm
1 x		1/4" / 1/2"
7 x		3 - 4 - 5,5 - 6,5 mm PH0 - PH1 - PH2
1 x		T8 - T10 - T15 - T20 - T25 - T27 - T30 T40 - T45 - T50
1 x		1,5 - 2 - 2,5 - 3 - 4 - 5 - 6 - 8 - 10 mm
1 x		
1 x		300 g
1 x		160 mm
1 x		200 mm



B

1/4" + 1/2"

A

matné
satinovanie

B

vysoký lesk
pochromovaný

A

917.0797



97

174,90 €

B

918.0797



97

189,90 €

poniklovaný



A

od
174,90

i **88**
 Další informace



1/4"		4 - 4,5 - 5 - 5,5 - 6 - 7 - 8 - 9 - 10 - 11 12 - 13 mm
1/2"		14 - 15 - 16 - 17 - 18 - 19 - 20 - 21 - 22 23 - 24 - 25 - 26 - 27 - 28 30 - 32 mm
12 x		6 - 7 - 8 - 9 - 10 - 11 - 12 - 13 - 14 17 - 19 - 22 mm
3 x		1/4": 50 - 100 mm / 1/2": 125 mm
1 x		1/4"
4 x		6,5 - 8 mm PH1 - PH2
1 x		1/4"
1 x		1/4"
1 x		150 - 250 V
1 x		250 mm
1 x		180 mm
1 x		300 g



189,90



matne satinovaný

911.0688

1/4" + 1/2"

i **127**
 Další informace

UNIVERZÁLNÝ



369,90

911.0727

1/4" + 1/2"



Ďalšie informácie



1/4"		4 - 4,5 - 5 - 5,5 - 6 - 7 8 - 9 - 10 - 11 - 12 13 mm
1/2"		10 - 13 - 14 - 15 - 16 17 - 18 - 19 - 21 - 22 24 - 27 - 30 - 32 mm
10 x		8 - 10 - 11 - 12 - 13 14 - 15 - 17 - 19 - 22 mm



389,90

911.0649

1/4" + 1/2"

**PLNÁ VÝBAVA?
TAK PREJDITE SEM!**



Ďalšie informácie

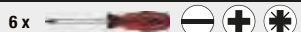

9 x		1,5 - 2 - 2,5 - 3 - 4 - 5 - 6 8 - 10 mm
9 x		TS10 - TS15 - TS20 - TS25 TS27 - TS30 - TS40 - TS45 TS50



1/4"		4 - 4,5 - 5 - 5,5 - 6 - 7 8 - 9 - 10 - 11 - 12 13 mm
1/2"		10 - 11 - 12 - 13 - 14 15 - 16 - 17 - 18 - 19 21 - 22 - 24 - 27 - 30 32 mm
11 x		8 - 9 - 10 - 11 - 12 13 - 14 - 16 - 17 - 19 22 mm



449,90

911.0630

1/4" + 1/2"



Ďalšie informácie

PRE ELEKTRIKÁROV

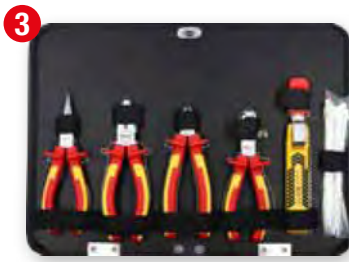

4 x

1/4" 4 - 4,5 - 5 - 5,5 - 6 - 7 - 8
9 - 10 - 11 - 12 - 13 mm

1/2" 10 - 11 - 12 - 13 - 14 - 15
16 - 17 - 18 - 19 - 21 - 22 mm

10 x 8 - 10 - 11 - 12 - 13 - 14
15 - 17 - 19 - 22 mm

1/4" + 1/2"

911.0628

389,90



Ďalšie informácie

UNIVERZÁL



1/4" 4 - 5 - 6 - 7 - 8 - 9 - 11
12 - 13 mm

1/2" 10 - 11 - 12 - 13 - 14 - 15 - 16
17 - 18 - 19 - 21 - 22 - 24 mm

10 x 8 - 9 - 10 - 11 - 12 - 13
14 - 16 - 17 - 18 - 19 mm

1/4" + 1/2"

911.0735

519,90



99



Ďalšie informácie

TRUHLICE S POKLADOM!



99



Ďalšie informácie



1/4"	4 - 5 - 6 - 7 - 8 - 9 - 10 - 11 - 12 13 - 14 mm
1/2"	13 - 15 - 17 - 18 - 19 - 20 - 21 - 22 24 - 27 - 30 - 32 mm



PRSTENCOVÝ KLÚČ S RAČŇOU

8 - 9 - 10 - 11 - 12 - 13 - 14 - 15 - 16 - 17 - 18 - 19 mm

MÁTE NA VÝBER!

PRSTENCOVÉ KLÚČE

8 - 9 - 10 - 11 - 12 - 13 - 14 - 15 - 16 - 17 - 18 - 19 mm



599,90

1/4" 1/2"



519,90

1/4" 1/2"

918.0100



918.0200



40



Ďalšie informácie

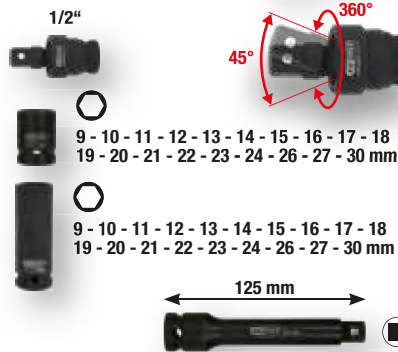

114,90

1/2"

515.0065





1
Ďalšie informácie



R
L

ERGOTORQUE

PRECISION



od
99,90



Stupnica s lupou



Mikrometrická stupnica



10 výměstevní a moštie gnie kalibrácie:
DIN EN ISO 6799
Certifikát
Právnosť
0,3%

		Nm	Delenie Nm	Lbf-ft		
516.1402		1/4"	1-5	0,10	0,8 - 3,6	99,90 €
516.1412		1/4"	5-25	0,10	0,8 - 18	99,90 €
516.1422		3/8"	10-50	0,25	4 - 37	99,90 €
516.1432		1/2"	20-100	0,50	8 - 75	110,90 €
516.1442		1/2"	40-200	1,00	15 - 150	110,90 €
516.1472		1/2"	60-320	1,00	45 - 236	124,90 €
516.1482		1/2"	80-420	1,00	60 - 310	135,90 €
516.1493		3/4"	150-750	10,00	150 - 550	588,90 €
516.1495		1"	200-1000	20,00	220 - 730	673,90 €





22
Ďalšie informácie

3 V 1



1 2 3



A



B

DLHÝ

9,90



+
DLHÝ

12,90

A	151.2100		8		2 - 2,5 - 3 - 4 - 5 - 6 8 - 10 mm	9,90 €
B	151.2300		8		T10 - T15 - T20 - T25 T30 - T40 - T45 - T50	9,90 €





22
Ďalšie informácie

3 V 1



1 2 3



A



B

DLHÝ

9,90



+
DLHÝ

12,90

A	151.2100		8		2 - 2,5 - 3 - 4 - 5 - 6 8 - 10 mm	9,90 €
B	151.2300		8		T10 - T15 - T20 - T25 T30 - T40 - T45 - T50	9,90 €

32
Ďalšie informácie

poniklovaný

1 x		1/4"
1 x		1/4"
3 x		PH1 - PH2 - PH3
6 x		2 x PZ1 - 2 x PZ2 - 2 x PZ3
3 x		5,5 - 6,5 - 8 mm
3 x		4 - 5 - 6 mm
15 x		2 x TB10 - 3 x TB15 - 2 x TB20 3 x TB25 - 3 x TB30 - 2 x TB40

911.2060

25 mm

50 mm

8,90

32
Ďalšie informácie

TORION power

+30%

1 x		1/4"
1 x		1/4"
4 x		3 - 4 - 5 - 6 mm
4 x		PH1 - 2 x PH2 - PH3
4 x		PZ1 - 2 x PZ2 - PZ3
4 x		3 - 4 - 5 - 6 mm
7 x		T10 - T15 - T20 - T25 - T27 - T30 - T40
7 x		TB10 - TB15 - TB20 - TB25 - TB27 - TB30 - TB40

911.3030

108
Ďalšie informácie

TORION power

29,90

NOVINKA

6x		4 - 5 - 6 mm
6x		4 - 5 - 6 mm
6x		PH1 - PH2 - PH3
6x		PZ1 - PZ2 - PZ3
6x		T10 - T15 - T20 - T25 - T30 - T40

918.3108

25 mm

+30%

108 BITOV, KTORÉ ROBIA ROZDIEL

32
Ďalšie informácie

68 mm

100 mm

-22,1%

-49%

4 x		3 - 4 - 5 - 6 mm
4 x		PH1 - 2 x PH2 - PH3
4 x		PZ1 - 2 x PZ2 - PZ3
4 x		3 - 4 - 5 - 6 mm
7 x		T10 - T15 - T20 - T25 T27 - T30 - T40
7 x		TB10 - TB15 - TB20 - TB25 TB27 - TB30 - TB40

918.3010

44,90

TORION power

57,90

31
Ďalšie informácie

2 x		4 - 5 mm
3 x		PH1 - PH2 - PH3
3 x		PZ1 - PZ2 - PZ3
9 x		1,5 - 2 - 2,5 - 3 - 4 - 5 - 6 7 - 8 mm
11 x		T6 - T7 - T8 - T9 - T10 - T15 T20 - T25 - T27 - T30 - T40

918.3015

57,90

TORION power

i **24**
 Další informace

MALÉ, ALE PRAKTICKÉ

25 mm
 poniklovaný

19,90

1 x		1/4": 92 mm
1 x		1/4": 50 mm
1 x		1/4"
6 x		6 - 7 - 8 - 10 - 11 - 13 mm
2 x		PH1 - PH2
2 x		PZ1 - PZ2
2 x		4,5 - 5,5 mm
4 x		3 - 4 - 5 - 6 mm
5 x		TB10 - TB15 - TB20 - TB25 - TB30

911.2010 **1/4"**

i **208**
 Další informace

39,90

VŠESTRANNÝ SKRUTKOVÁČ!

1/4"		1/4": 205 mm
138 x		25 mm
29 x		50 mm
18 x		75 mm
20 x		4 - 5 - 6 - 7 - 8 - 9 - 10 - 11 - 12 - 13 mm 5/32" - 3/16" - 7/32" - 1/4" - 9/32" 5/16" - 11/32" - 3/8" - 7/16" - 1/2"
1 x		1/4": 50 mm
1 x		1/4"

911.2008 **1/4"**

i **7**
 Další informace

MALÝ TECHNOLOGICKÝ ZÁZRAK!

9,90

6 IN ONE

110 mm

1/4"

159.2025 6 v 1 Mini skrutkovač s račňou

NOVINKA

36

i **13**
 Další informace

14,90

12 IN ONE

240 mm

1/4"

159.2035 Račňový bitový skrutkovač 12v1

1
 Ďalšie informácie

2 V 1

1/4"

ALEBO

8,90

514.1126

85 mm

1
 Ďalšie informácie

1/4"

10,90

S KLĚBOM

90 mm

20°

514.1136

21
 Ďalšie informácie

4 mm

30 mm

165 mm

Ø 16 mm

39,90

500.7195

1 - 1,3 - 1,5 - 2 - 2,5 - 3 mm

PH00 - PH0 - PH1 - PH2

1,5 - 2 - 2,5 - 3 - 3,5 mm

T3 - T4 - T5 - T6 - T7

27
 Ďalšie informácie

LED

1/4"

eMONSTER

STAČÍ JEDEN DOTYK, ABY STE SI ZAMILOVALI.

34,90

515.3600

max 6 Nm

max 4 Nm

max 2 Nm

4x		3,0 - 4,0 - 5,0 - 6,0 mm
4x		3,0 - 4,0 - 5,0 - 6,0 mm
5x		PH0 - PH1 - PH2 - PH3
4x		PZ0 - PZ1 - PZ2 - PZ3
4x		T10 - T15 - T20 - T25
4x		#0 - #1 - #2 - #3
1x		PH1
1x		50 mm
1x		Max. 6 Nm

3,6 V

1.500 mAh

300 rpm

USB-C

2+ LED



51



Ďalšie informácie

UNIVERZÁL



1 Vrtanie



2 Čistenie



3 Brúsenie



23x



4 Gravírovanie

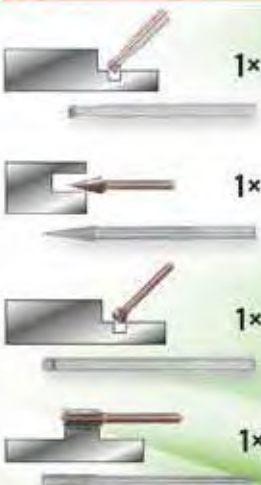

5 Rezanie



6 Leštenie



eMONSTER Súprava
akumulátorového
multifunkčného náradia
s 50 dielmi príslušenstva



eMONSTER



49,90

515.3990



50



Ďalšie informácie

NA DOKÚPENIE



Súprava príslušenstva, 50-dielna

9,90

515.3992

TRANSFORMER MEDZI SKRUTKOVÁČMI



eMONSTER

Vysoké otáčky
210 ot./min
zaručujú 5-krát
rychlejšie
utáhovanie v
porovnaní
s ručným
utáhováním

zosilnený prevod

praktický indikátor
stavu nabitia batérie
s 3 LED diódami



Zariadenie 2v1 s vyváženým pomerom medzi výkonom a veľkosťou, ideálne pre prácu nad hlavou a v stiesnených priestoroch.

magnetické bitové
uchytenie



predvoľba krútiaceho momentu
nastaviteľná v 10 krokoch



vylepšený
uchopovací
komfort



1,3 Ah batéria
s výdržou viac
ako
1000
skrutiek

Vďaka prípojke USB-C je
vysokovýkonná lítium-iónová
batéria rýchlo nabitá a pripravená
na použitie.

integrovane
svietidlo



Pretočeniu skrutiek zabránuje
automatické zablokovanie motora pri
prekročení utáhovacieho momentu.



Ďalšie informácie

vrát. 25
bitov



39,90

515.6500



i **5** **159.0005**

Ďalšie informácie

9,90

PH1 PH2 6,5 mm 5,5 mm 4 mm

i **6** **159.0030**

Ďalšie informácie

19,90

T10 T15 T20 T25 T30 T40

i **6** **159.0040**

Ďalšie informácie

19,90

TB10 TB15 TB20 TB25 TB30 TB40

i **39**

Ďalšie informácie

50,90

6 x		3 - 4 - 5,5 - 6,5 - 8 - 10 mm	7 x		2 - 2,5 - 3 - 4 - 5 6 - 8 mm
5 x		PH0 - PH1 - PH2 PH3 - PH4	7 x		TB10 - TB15 - TB20 TB25 - TB27 - TB30 TB40
4 x		PZ0 - PZ1 - PZ2 PZ3	7 x		T10 - T15 - T20 T25 - T27 - T30 T40
1 x		6 mm	1 x		1/4"
1 x		PH2	1 x		205 mm

159.0100 **1/4"**

i **13**

Ďalšie informácie

NEUVERITEĽNE ODOLNÝ!

67,90

priechodná čepeľ

5 x		3,5 - 5,5 - 7 - 8 - 10 mm
5 x		PH0 - PH1 - PH2 - PH3 - PH4
1 x		6 mm
1 x		PH2
1 x		1/4"

151.1150 **1/4"**

i  **15**
 Další informace

260 mm



A

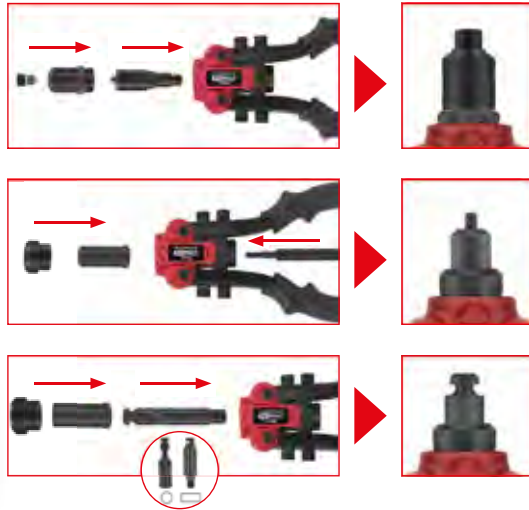

67,90

150.9805









Nity (hliník)



Nity (ocel)



Matica

		A	B
		150.9805	150.9630
	v kufrí	✓	✓
	dĺžka mm	260	510
	nožnice na plech	✓	✗
	obsluha jednou alebo dvomi rukami		
	M10	✓	✓
	M8	✓	✓
	M6	✓	✓
	M5	✓	✓
	M4	✓	✓
	M3	✓	✓
	Oceľ 4,8 mm	✓	✓
	Oceľ 4,0 mm	✓	✓
	Oceľ 3,2 mm	✓	✓
	Oceľ 2,4 mm	✓	✓
	Hliník 6,4 mm	✓	✓
	Hliník 4,8 mm	✓	✓
	Hliník 4,0 mm	✓	✓
	Hliník 3,2 mm	✓	✓
	Hliník 2,4 mm	✓	✓

i  **17**
 Další informace

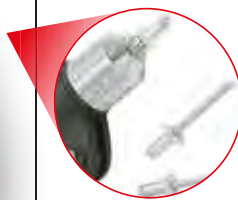

B

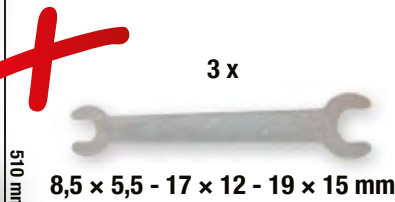

3 x
8,5 x 5,5 - 17 x 12 - 19 x 15 mm



5 x
M4 - M5 - M6 - M8 - M10



6 mm

174,90

150.9630





1

Ďalšie informácie











35 - 90 mm



od 10,⁹⁰

	↔	↔	
115.2011	175 mm	7"	10, ⁹⁰ €
115.2010	240 mm	10"	12, ⁹⁰ €
115.2012	300 mm	12"	15, ⁹⁰ €
115.2016	415 mm	16"	31, ⁹⁰ €







4

Ďalšie informácie

CrV	DIN 5254 A	DIN 5254 B	DIN 5256 C	DIN 5256 D
-----	------------	------------	------------	------------

PRÉMIOVÁ KVALITA!





4

Ďalšie informácie



A 19 - 60 mm



B 40 - 100 mm

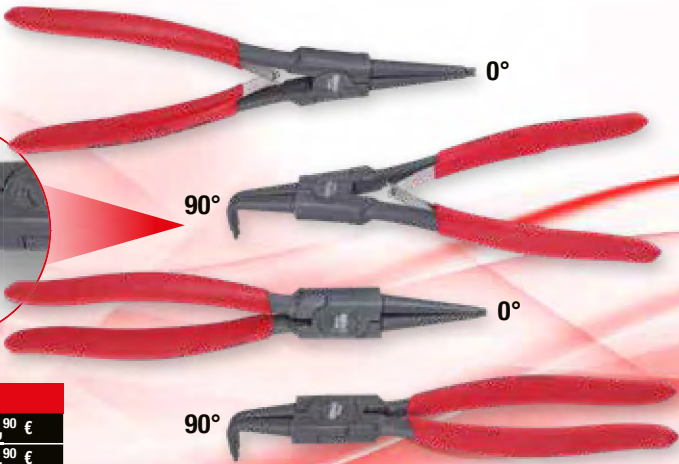

od 110,⁹⁰

	↺ ↻	↔	
A	119.2055	19 - 60 mm	160 mm 110, ⁹⁰ €
B	119.2060	40 - 100 mm	230 mm 124, ⁹⁰ €





20

Ďalšie informácie

BEZPEČNOSŤ NA PRVOM MIESTE



60 - 100 mm



40 - 85 mm









49,⁹⁰

500.1350

Súprava klieští s poistkou s funkciou račne

POZRI SA MI DO OČÍ, MILÁČIK!

i **10**
 Ďalšie informácie

24,90

260 mm

300 mm

500.7220

1 x		120 mm	1 x		160 mm
1 x		120 mm	3 x		PH00 - PH0 - PH1
1 x		120 mm	3 x		2,0 - 2,4 - 3,0 mm

ESD

i **21**
 Ďalšie informácie

99,90

430 mm

370 mm

500.7190

2 x		125 - 130 mm	3 x		PH00 - PH0 - PH1
1 x		100 mm	4 x		1,4 - 2,0 - 2,4 - 3,0 mm
1 x		100 mm	7 x		T6 - T7 - T8 - T9 T10 - T15 - T20
1 x		125 mm			
1 x		150 mm			
1 x		145 mm			

i **1**
 Ďalšie informácie

so stabilným nastavovacím hrotom podobným rysovacej ihle

500g

150 - 675 mm

Ø 8,0 mm

5,90

s pevnou magnetickou hlavou

2v1 teleskopický magnetický držiak s nástrojom na čistenie a nastavovanie ostrekovacích dýz

550.1001

i **1**
 Ďalšie informácie

s tenkou čistiacou tyčou

2,5 kg

150 - 590 mm

Ø 11,0 mm

7,90

s flexibilnou magnetickou hlavou

2v1 teleskopický magnetický držiak s nástrojom na čistenie a nastavovanie ostrekovacích dýz

550.1023

i **1**
 Ďalšie informácie

9,90

260 - 760 mm

max. 60 h

1 x CR 2032

LED

50 x 80 mm

Flexibilné inšpekčné zrkadlo s osvetlením

550.1136

i **5**
 Ďalšie informácie

vrátane rýchleho zaistovania

NOVINKA

14,90

5 V 1

3 x LR44

LED

Ø 52,0 mm

Ø 31,0 mm

90,0 x 50,0 mm

172 - 640 mm

3,6 kg

550.1145

i **4**
Ďalšie informácie

9,90

45° 135° 0° 90°

550.1045

i **9**
Ďalšie informácie

19,90

45° 135° 0° 90° 45° 90° 0°

550.1070

i **1**
Ďalšie informácie

8,90

Piezo

115 mm

960.1110

i **1**
Ďalšie informácie

19,90

300 mm

550.1060

i **8**
Ďalšie informácie

19,90

95 mm

Ø 40 mm

49 mm

5 mm

Ø 1,6 mm

Ø 3,5 mm

Ø 4,5 mm

ISO BUTAN

960.1265

i **11**
Ďalšie informácie

29,90

Piezo

200 mm

20 mm

33 mm

Ø 1,6 mm

Ø 3,5 mm

Ø 4,5 mm

Ø 5 mm

30 mm

95 mm

95 mm

Ø 40 mm

Súprava mikrospájok

960.1160

i **283**
Ďalšie informácie

115.1400

169,⁹⁰

220 mm

Ø 0,5 - 6 mm

Ø 0,5 - 6 mm

Ø 0,5 - 10 mm

Ø 6,50 / 5,41 / 1,72 mm

Ø 0,5 - 4 mm

Ø 1,0 - 3,2 mm

i **1**
Ďalšie informácie

118.0013

3,⁹⁰

143 mm

i **1**
Ďalšie informácie

EG II

od 2,⁹⁰

A 16 mm

B 19 mm

C 25 mm

D 25 mm

	300.0113	300.0114	300.0115	300.0116
A	3 m	5 m	5 m	8 m
B	16 mm	19 mm	25 mm	25 mm
C	2,90 €	3,90 €	4,90 €	5,90 €
D				

i **5**
Ďalšie informácie

960.1190

29,⁹⁰

Regulácia teploty: 1≈50°C / 2≈100°C / 3≈200°C / 4≈350°C / 5≈550°C / 6≈650°C

260 mm

1 2 3 4 5 6

1 max. 450°C

2 max. 650°C

Oblasti použitia: odstraňovanie farby, spájkovanie rúr, zmršťovanie PVC, zváranie a ohýbanie plastov, sušenie, topenie atď.

i **1**
Ďalšie informácie

150.4217

134,⁹⁰

IP 34

15+1 m

3x 1,5 mm²

230 V 50 Hz

1000/3000 W

10 A

180°

i **12**
Ďalšie informácie

140.3050

9,⁹⁰

145 mm

5,0 x 1,0 mm

5,0 x 1,0 mm

3,0 mm

3,0 mm

5,0 mm

5,0 mm

3,0 mm

2,0 mm

2,0 mm

5,0 mm

5,0 mm

5,0 mm

5,0 mm

i **5**
Ďalšie informácie

140.3000

29,⁹⁰

200 mm

i **1**

Ďalšie informácie

138 x 69 x 31 mm 342 9 V

19,90

69 mm 138 mm

150.1495

i **1**

Ďalšie informácie

3 - 48 V

140 mm

11,90

Skúšačka polarit
a napätia 3 - 48 V

550.1503

i **1**

Ďalšie informácie

125 mm

6 - 24 V

4,90

Skúšobná lampa 6 - 24 V

550.1504

i **1**

Ďalšie informácie

AUTOMATIC
DIGITAL MULTIMETER

143 x 70 x 16 mm 119 AAA

16 mm

143 mm

70 mm

49,90

NCV

USB-A USB-C

Nie Popis

1	Vypínač
2	Prepínač funkcií
3	Kapacitný spínač
4	Vypínač osvetlenia
5	Displej LCD
6	Oblasť snímača NCV
7	Testovacie vodiče

Symbol	Popis
	DC napätie
	Striedavé napätie
	Indikátor automatického vypnutia
	Indikátor slabšej batérie
	Diódový režim
	Priechod
	Kapacita
	Pomer merača výkonu
HOLD	Funkcia uchovávania údajov
V, mV	Jednotka napätia: volt, milivolt
mF, µF, nF	Jednotka kapacity
MΩ, KΩ, Ω	Jednotka odporu
NCV	Bezkontaktná indukcia napätia
Live	Testovanie živých vedení
KHz, Hz	Jednotka frekvencie
°C/°F	Celzia/Fahrenheita

150.1765

i **3**
 Ďalšie informácie

210 x 88 x 44 mm
 655
 9 V
 Data Hold

27,0 mm

34,90

max. merateľný priemer vedenia 29,0 mm

150.0925

i **1**
 Ďalšie informácie

na jednosmerné a striedavé napätie

AC	6 - 50 - 120 - 230 - 400 V
DC	6 - 50 - 120 - 230 - 400 V

23,90

550.1501

UNIVERZÁLNY KLÚČ PRE ELEKTRICKÉ SKRIŇOVÉ ROZVÁDZAČE

i **1**
 Ďalšie informácie

MINI

42 mm

- 6 - 7 - 8 mm
- ▲ 9 mm
- 3 - 5 mm
- ⊕ PH 2
- ⊖ 7 mm

16,90

130.1010

i **1**
 Ďalšie informácie

71 mm

- 6 - 7 - 8 mm
- ▲ 9 mm
- 3 - 5 mm
- ⊕ PH 2
- ⊖ 7 mm

17,90

130.1015

i **1**
 Ďalšie informácie

61 mm

- 5 - 7 - 8 mm
- ▲ 9 - 10 mm
- 4 - 10 mm
- ⊕ PH 2
- ⊖ 7 mm

17,90

130.1020

Sťahovací drôt pre káble

10 metrov 20 metrov

od 4,90

A	150.0960		1	∅ 3,0 mm 10 m	4,90 €
B	150.0970		1	∅ 4,0 mm 20 m	9,90 €

i **1**
 Ďalšie informácie

34,90

∅ 3,0 mm

30 metrov

Pomôcka na vtáňovanie káblov

115.1113

i  **1**
 Ďalšie informácie

22,90



- aretáciou momentu
- meracie lišty s dielikmi v mm a palcoch
- s tabuľkou na rezanie závitov

300.0510

i  **1**
 Ďalšie informácie

24,90



+/- 0,03 mm

- s nastavovacou skrutkou a jemným nastavením valčekom
- na meranie vonkajších, vnútorných rozmerov, schodov a hĺbok

300.0532

i  **1**
 Ďalšie informácie

**INFRAČERVENÝ
 TEPLOMER,
 -38° - 520°**



49,90

150.3040

i  **4**
 Ďalšie informácie

56,90



Refraktometer - optický testovací prístroj pre batériovú kvapalinu a nemrznúcu zmes

550.1290

i  **4**
 Ďalšie informácie

67,90



Refraktometer - optický skúšobný prístroj na batériovú kvapalinu, nemrznúcu kvapalinu a prísady AdBlue®

550.1285

i **4**
 Ďalšie informácie

19,90

11 x 115 mm
 15 x 185 mm
 18 x 320 mm
 18 x 470 mm

911.8100 Súprava montážnych pák

i **4**
 Ďalšie informácie

XL

900 mm
 600 mm

0°
 45°
 75°
 90°

179,90

911.8410 Súprava montážnych pák

i **22**
 Ďalšie informácie

Súprava 2 + 3 ramenných univerzálnych hydraulických stahovákov

- malé nebezpečenstvo zošmyknutia vďaka automaticky zatváreným ramenám stahovávka
- možných 8 variantov stahovávka
- extrémne robustné vreteno s indukčne tvrdým závitom
- vynaloženie malej sily
- špeciálna nástrojová oceľ

304,90

700.1200

10 t, AG 1.1/2" x 16G

20 - 35 - 85 mm
 235 mm
 185 mm

225 mm
 170 mm
 120 mm

Ø max. 100 mm

i **13**
 Ďalšie informácie

NOVINKA **PRE PRÍPAD NÚDZE**

79,90

0% ✓ 85% ✓

na povoľovanie a odskrutkovanie uviaznutých matic a skrutiek s poškodenými hlavami alebo až na 85% „pretočených“ hláv

89,90

očká zahnuté o 45°

913.3930 8 - 9 - 10 - 11 - 12 - 13 - 14 - 15 - 16 - 17 - 18 - 19 mm **3/8"**

517.1555 6x7 - 8x9 - 10x11 - 12x13 - 14x15 - 16x17 - 18x19 mm

SOM SKRUTKA, DOSTAŇ MA ODTIALTO!



Ďalšie informácie

- na skrutky M3 - M18
- umožňuje vyskrutkovanie odtrhnutých skrutiek a svorníkov
- kuželovitá špirála
- v stabilnom plastovom boxe



150.1330 Súprava vyvrtávačov skrutiek

16,90

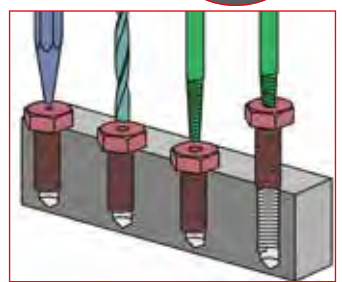
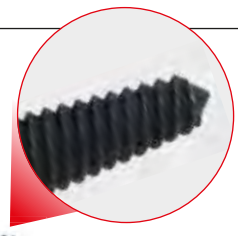

Ďalšie informácie

TORION power

44,90

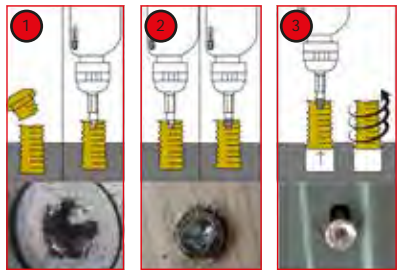

- 9 x TE10 - TE15 - TE20 - TE25 - TE27 - TE30 - TE40 - TE50 - TE55
- 9 x 1,5 - 2 - 2,5 - 3 - 4 - 5 - 6 - 8 - 10 mm
- 7 x 1,5 - 2 - 2,5 - 3 - 4 - 5 - 6 mm
- 7 x T10 - T15 - T20 - T25 - T27 - T30 - T40



150.7060 1/4" + 10 mm Súprava vyťahovákov na skrutky TX a skrutky s vnútorným šesťhranom



Ďalšie informácie

Súprava na odvrtávanie zo závitov

- rozsiahla súprava
- na odstraňovanie odlomených závitových čapov a skrutiek
- žiadne poškodenie závitů
- len malé rozšírenie závitových čapov vďaka špeciálne profilovaným vyvrtávacím kolíkom



Führungshülse drill guide	Hülse Innen- Ø mm guide	vorböhren Ø mm pre-drilling	aufbohren re-drilling	Stift pin	Art.Nr. Stift No. Pin	Mutter D nut D	Art.Nr. Mutter nut D	Stift + Mutter pin + nut
150.0501	4,0 / 3,2	3,2	-	3,2	150.0521	SW 10	150.0511	150.0511S
150.0502	4,8 / 3,2	3,2	-	3,2	150.0521	SW 10	150.0511	150.0511S
150.0503	4,8 / 3,2	3,2	4,8	4,8	150.0522	SW 11	150.0512	150.0512S
150.0504	4,8 / 3,2	3,2	4,8	4,8	150.0522	SW 11	150.0512	150.0512S
150.0505	6,0 / 4,8	4,8	6,4	6,4	150.0523	SW 13	150.0513	150.0513S
150.0506	7,0 / 4,8	4,8	6,4	6,4	150.0523	SW 13	150.0513	150.0513S
150.0507	7,0 / 4,8	4,8	8,0	8,0	150.0524	SW 14	150.0514	150.0514S
150.0508	7,0 / 4,8	4,8	8,7	8,7	150.0525	SW 17	150.0515	150.0515S
150.0509	9,0 / 6,5	6,4	8,7	8,7	150.0525	SW 17	150.0515	150.0515S
150.0510	9,5 / 6,5	6,4	8,7	8,7	150.0525	SW 17	150.0515	150.0515S



150.1305 M5 - M6 - M8 - M10 - M12 - M14 - M16

39,90

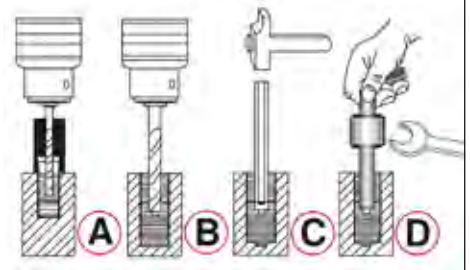



Ďalšie informácie

Vyvrtač podporných čapov - súprava

49,90

- pohon s vonkajším šesťhranom 21,0 mm
- funkcia upínania doprava a doľava
- bezpečné držanie vďaka 3 valčekom
- zakrúcanie a vykrúcanie bez zdĺhavého kontrovania dvoch matic na svorníku
- vhodný aj na nadmerne dlhé svorníky - vďaka priečodnému vrtaniu



M5

M6

M7

M8

M10

M12

M14



152.1101 M5 - M6 - M7 - M8 - M10 - M12 - M14



Ďalšie informácie

HSS Co súprava nástrojov na rezanie závitov v priemyselnej kazete



- univerzálna súprava
- rovno drážkovaný ručný závitník
- s nastaviteľným vratidlom a vratidlom na kruhové čeluste
- vrátane závitovej mierky a skrutkovača
- kobaltovaná vysokovýkonná oceľ

NIČ MU NECHÝBA



33 x		M3 - M4 - M5 - M6 - M8 - M10 - M12 M14 - M15 - M18 - M20
11 x		M3 - M4 - M5 - M6 - M8 - M10 - M12 M14 - M15 - M18 - M20
6 x		M3-M4 - M4,5-M6 - M7-M9 - M10-M11 - M12-M14 - M16-M20
2 x		M1-M10 - M5-M20

499,90

331.0754



Ďalšie informácie

KAŽDÝ JU RÁD NOSÍ!

24,90



EN388



4131X

Mikro jemný úplet

	Veľkosť	Obsah
310.0490	7	12 párov
310.0491	8	12 párov
310.0470	9	12 párov
310.0475	10	12 párov
310.0480	11	12 párov



Ďalšie informácie

3,90



310.0120

FLAME DESIGN

Ďalšie informácie





49,90

310.0155

STEEL DESIGN

Ďalšie informácie





49,90

310.0195



Technické údaje:

Výber farby:	plynulo regulovateľné podľa DIN 9-13
	Štandardné nastavenie svetla: DIN 4
Prepínacia reakčná doba:	1/25.000 s
	0,2 - 0,8 s oneskorenie (nastaviteľné)
Ochrana proti UV/Ľ:	podľa EN169 / až DIN 16
Prevádzková teplota:	-5 °C až + 55 °C
Skladovacia teplota:	-20 °C až + 70 °C
Napájanie prúdom:	cez solárne články
Výška:	220 mm
Šírka:	200 mm
Dĺžka:	295 mm
Hmotnosť:	480 g
Rozmery kazety:	110 x 90 x 9 mm
Prizorové sklo:	92 x 42 mm

Univerzálny tlakový rozprašovač

Ďalšie informácie

- z kvalitného polyetylénu
- pre rôzne chemikálie, ako napr. pracie prostriedky, rozpúšťadlá a čistiace prostriedky atď.
- nevhodný pre čističe brzd
- stříekacia hlava z mosadze je nastaviteľná a zablokovateľná
- tesnenia z Viton®u
- vhodný pre prácu dole hlavou



od 14,90

150.8251 1L 14,90 €
150.8252 2L 19,90 €

0,25 L

max. 8 bar (116 psi)

60°C / 140°F

115 mm

NOVINKA

0,25 L

Aluminium

49,90

150.8272

Špeciálne pre čističe brzd

i **16**
Ďalšie informácie

EVOLUTION SERIES

Súprava škrabiek na drážky

- ideálny na odstraňovanie plagátov, zvyškov tesnení a lepidla
- jednoduchá výmena čepele uvoľnením ryhovanej skrutky na skľučovadle
- praktický úschovný systém vďaka vymeniteľným tvarom čepeľí
- mimoriadne vhodný pre najrozličnejšie oblasti použitia vďaka rôznym čepeľom
- škrabák s 2-zložkovou rukoväťou

Náhradné čepele: 907.2202, 907.2203, 907.2204, 907.2205, 907.2206

NOVINKA

5x 12 mm
 5x 16 mm
 5x 20 mm

145 mm

12,90

907.2255

i **27**
Ďalšie informácie

Súprava nožov a škrabiek

145 mm

5x 19 mm

5x 12 mm
 5x 16 mm
 5x 16 mm
 5x 20 mm

145 mm

19,90

907.2200

Škrabka na nálepky

A 110 mm
 B 145 mm

od 3,90

A	907.2240			110 x 39 mm	3,90 €
B	907.2242			145 x 40 mm	4,90 €

Vreckový nožik s aretáciou

A 190 mm
 B 220 mm

od 10,90

A	907.2105			190 x 25 mm	10,90 €
B	907.2190			220 x 28 mm	11,90 €

i **2**
Ďalšie informácie

155 mm 97 mm

14,90

907.2172 **Súprava sklápacích nožov**

i **3**
Ďalšie informácie

250 mm

39,90

118.0050 **Sada nožníc na plech**

i **5** **WiFi súprava obrazových osciloskopov s Ø 5,5 mm 0° HD sonda prednej kamery**

Ďalšie informácie

HD

Ø 5,5 mm

3500 mm

Ø 5,5 mm

IP68

WiFi

39,90

550.7560

EXTEND YOUR EYE

od **239,90**

Nerezové puzdro
Skrutková prípojka pre príslušenstvo

Korunkový dizajn (ochrana + optimálne čistenie)

Kamera
Šošovka
LED dióda
Nerezové puzdro s vonkajším závitom
Zafírové sklo

Ø 6,0 mm

PUSH 0 / 90°

1000 mm

Pripojka sondy

3,5"

USB 2.0

microSD

1500 mAh Li-polymer

HD

6 stmievateľných mini LED žiaroviek

Ø

0° 90°

Ø 4,5 mm

Magnet

Magnet

Hák

IP 67

AVI 1280 x 720

JPG

150 mm

-10°/+60°C

A	550.7500		5	6,0 mm	0° + 90°	239,90 €
B	550.7530		7	4,5 mm	0° + 90°	299,90 €





Ďalšie informácie



Ø
3,9 mm

6 stmievateľných
mini LED
žiaroviek

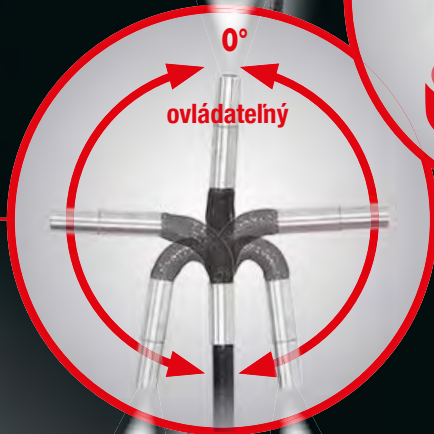

0°
ovládateľný

180°

180°



otočný
360°
otočný



Prípojka sondy



USB 2.0
microSD



3000 mAh
Li-polymer

IP
67

AVI
1280 x 720

JPG

150 mm

-10°/+60°C

NOVINKA

Súprava HD obrazových osciloskopov s Ø 3,9 mm
180° a 0° HD sonda prednej kamery, ohybný PVC kryt

550.7550

+ 32 GB

449,90



SHK

Ø 12 - 35 MM



104.5060

Inox

Steel

Račňový trubkorez



39,⁹⁰



Ø 28 - 67 MM



104.5050

Inox

Steel

Račňový trubkorez



129,⁹⁰



116.1050

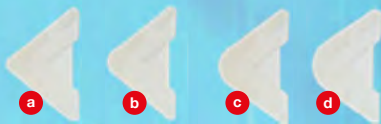

FUGENFIX[®]



7,⁹⁰



FUGENFIX súprava silikónových škrabákov a odtáhovačov



903.3300

Súprava závitníc 3/8" - 1.1/4"

3/8"
1/2"
3/4"
1"
1.1/4"

79,⁹⁰



116.2000



57,90

Ventilifix

130.3000

1/2"

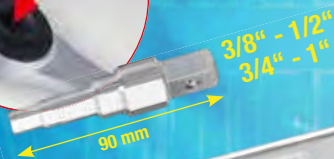

19,90

Súprava univerzálnych stupňových kľúčov 3/8\" - 1\"

903.5902

- teplota plameňa cca 1700 °C
- pracovná teplota cca 650 °C
- mäkké spájkovanie do max. Ø 22 mm
- dodávka sa realizuje bez plynovej kartuše
- použitie len so štandardným vysokovýkonným horákom
- základné teleso z plastu



24,90

Univerzálny kartušový spájkovací prístroj s piezo-zapaľovaním

907.2113

Japonská píla, s dvojítm ozubením



17x pro 2,5cm

8x pro 2,5cm

325 mm

17,90



850.0300

Univerzálna taška na náradie SMARTBAG

73,90

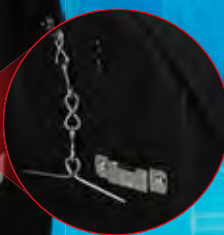

NOVINKA



Kompaktná a robustná konštrukcia:

Vďaka kvalitným plastom a pevným skrutkovým spojom ponúka akumulátor mimoriadne dobrú ochranu pred mechanickými vplyvmi.



18 V akumulátorový systém eMONSTER

Výkonný 18V akumulátorový systém eMONSTER je určený pre celý rad profesionálnych akumulátorových elektrických náradí. Všetky zariadenia je možné používať s jedným akumulátorovým systémom. Ponuka je široká, ale stále ju rozširujeme. S týmto akumulátorovým systémom je možné používať aj každé nové zariadenie. Tento batériový systém preto môžete používať dlhé roky a doplniť ho o 18V zariadení eMONSTER - nemusíte používať žiadne iné akumulátory.



Odvod tepla:

Vďaka rebrovej štruktúre je teplo odvádzané do okolitého vzduchu ako u chladiča.



Dodatočná ochrana pre dlhú životnosť akumulátora:

Prepätová ochrana:

- Ochrana proti nepripustným zdrojom vysokého napätia

Nízkonapäťová ochrana:

- Ochrana proti hlbkovému vybitiu počas prevádzky

Ovládanie teploty:

- Súhra zariadenia a akumulátora na zabránenie preťaženiu akumulátora



Aktívne chladenie vzduchom:

(iba s 8,0 Ah rýchlonabíjačkou). Integrovaný ventilátor 8,0 Ah rýchlonabíjačky nepretržite dodáva chladný čerstvý vzduch počas nabíjania pre maximálne možné zníženie tepla vznikajúceho v akumulátore a nabíjačke. Tento šetrný proces nabíjania výrazne zvyšuje životnosť akumulátora.



Optimalizované usporiadanie článkov:

Jednotlivé články sú vďaka rúrkovej konštrukcii zatlačené do plastu odvádzajúceho teplo. Tým sa vytvorí pevný kontakt medzi článkom a plastom odvádzajúcim teplo. Už tu nie je žiadna izolačná vrstva vzduchu, ktorá znižuje odvod tepla.





eMONSTER súprava bezuhlíkového akumulátorového vŕtacieho skrutkovača



eMONSTER súprava bezuhlíkového akumulátorového príklepového vŕtacieho skrutkovača

MINI

2-stupňová

150 mm

190 mm

LED

159,90

VRÁTANE

napätie akumulátora: 18,0 V
Max. nabijací prúd: 3 A

napätie akumulátora: 18,0 V
Akumulátorová technológia: Litium-iónový
Kapacita akumulátora: 2,0 Ah

dodávka vrátane dvoch 2,0 Ah akumulátorov a 3 A rýchlonabíjačky

2-stupňová

195 mm

198 mm

LED

189,90

Max. krútiaci moment: 40 Nm
Pohon: 10 mm rýchlopínadlo vŕtáka

Max. krútiaci moment: 60 Nm
Pohon: 13 mm kovové rýchlopínacie zariadenie vŕtáka Röhm



eMONSTER súprava 1/2" bezuhlíkového akumulátorového nárazového utáhača



eMONSTER súprava akumulátorovej uhlovej brúsky

215 mm

190 mm

predvoľba krútiaceho momentu nastaviteľná v 3 krokoch

Aretácia otáčania

15 mm, 17 mm, 19 mm, 21 mm, 22 mm

VRÁTANE

napätie akumulátora: 18,0 V
Max. nabijací prúd: 8 A

napätie akumulátora: 18,0 V
Akumulátorová technológia: Litium-iónový
Kapacita akumulátora: 4,0 Ah

dodávka vrátane dvoch 4,0 Ah akumulátorov a 8 A rýchlonabíjačky

230 mm

Ø 125 mm

320 mm

Napínací kľúč v bočnej rukoväti

6 rýchlostných stupňov

269,90

max. Uvoľňovací moment: 690 Nm
Pohon: 1/2"

Otáčky: 9000 ot./min
Vibračné zrýchlenie: < 4,831 m/s²
3,371 m/s²

299,90



- 1 x 1/4"
- 1 x 1/4"
- 4 x 3 - 4 - 5 - 6 mm
- 4 x PH1 - 2 x PH2 - PH3
- 4 x PZ1 - 2 x PZ2 - PZ3
- 4 x 3 - 4 - 5 - 6 mm
- 7 x T10 - T15 - T20 - T25 - T27 - T30 - T40
- 7 x TB10 - TB15 - TB20 - TB25 - TB27 - TB30 - TB40

NOVINKA

možnosť pripojenia a aretácie k 18 V zariadeniam eMONSTER ako fiktívny akumulátor

+30%

Ďalšie informácie

Súprava bitov 1/4" TORSIONpower v dizajne akumulátora eMONSTER, 32-dielna

9,90

515.6932

TOMU SA POVIE RÝCHLOSŤ!

1.390 N·m

1/2"

90 mm

165 mm

515.1150

1  **199,90**

1.390 N·m

1/2"

95 mm

190 mm

515.1270

2  **149,90**

1.084 N·m

1/2"

115 mm

180 mm

515.1315

3  **69,90**

1.600 N·m

1/2"

170 mm

188 mm

515.1200

4  **69,90**

2.000 N·m

3/4"

170 mm

185 mm

515.3400

5  **124,90**

1.690 N·m

1/2" 3/4"

175 mm

200 mm

515.1210

6  **149,90**

7  **189,90**

3.405 N·m

3/4" 1"

40 mm

350 mm

515.3250

9  **849,90**

11  **849,90**

3.405 N·m

3/4" 1"

195 mm

350 mm

515.3260

10  **904,90**

12  **904,90**

													
		MAX Nm	U/min	m/s ²	dB(A)	dB(A)	U/min	PT				Kg	
1	515.1150	1/2"	1390	10.000	<9,18	102,0	113,0	135	1/4"	-	✓	-	1,08
2	515.1270	1/2"	1390	10.000	<9,18	102,0	113,0	135	1/4"	-	✓	-	1,3
3	515.1315	1/2"	1084	9000	<10,36	106,0	115,0	169	1/4"	-	✓	-	1,2
4	515.1200	1/2"	1600	8500	<17,5	89,9	100,9	169	1/4"	✓	-	-	2,1
5	515.3400	3/4"	2000	8500	<17,25	91,0	100,9	196	1/4"	✓	-	-	2,2
6	515.1210	1/2"	1690	7930	<17,9	87,0	98,0	178	1/4"	✓	-	-	2,1
7	515.3785	3/4"	1690	7930	<13,56	88,0	104,0	178	1/4"	✓	-	-	2,2
8	512.0002	1/2"	2300	8500	<8,69	99,7	110,9	244	1/4"	✓	-	✓	1,6
9	515.3250	3/4"	3405	6200	<12,57	115,5	104,5	283	1/2"	✓	-	-	6,7
10	515.3260	3/4"	3405	6200	<12,88	115,5	104,5	283	1/2"	✓	-	-	7,7
11	515.3270	1"	3405	6200	<12,57	115,5	104,5	283	1/2"	✓	-	-	6,7
12	515.3280	1"	3405	6200	<12,88	115,5	104,5	283	1/2"	✓	-	-	7,8

 vysokovýkonný dvojitý mechanizmus úderov kladiva

 Vysokovýkonný úderový mechanizmus Jumbo

 technológia BITURBO

Všetky ceny v EUR bez DPH platia do 30.9.2024

i  **1**
 Ďalšie informácie

i **doprava maziva: jeden zdvih na jedno stlačenie**

200 mm
 400 g
 400 mm

66,50

515.3900 Pneumatický mazací lis na dopravu maziva prostredníctvom zdvihov

i  **1**
 Ďalšie informácie

od 24,90

PU ✓

515.3330	6,0 mm	G1/4" AG	8,0 m	24,90 €
515.3335	8,0 mm	G1/4" AG	15,0 m	34,90 €
515.3340	10,0 mm	G3/8" AG	15,0 m	39,90 €

i  **1**
 Ďalšie informácie

9,90

regulovateľný

100 mm

515.1901 Pneumatická vyfukovacia pištoľ s reguláciou prietoku

i  **3**
 Ďalšie informácie

19,90

510 mm
 330 mm
 95 mm

515.1921 Súprava pneumatických vyfukovacích pištoľí

Automatický navijak hadice na stlačený vzduch

15 m
 1,5 m

180°

STOP

i  **1**
 Ďalšie informácie

119,90

Ø 10 MM X 15 M

A

Technické údaje:
 Vnútorý priemer hadice: 10,0 mm
 max. Tlak: 20,0 bar
 Pripájací závit: 1/4"

515.3440

i  **1**
 Ďalšie informácie

179,90

Ø 13 MM X 15 M

B

Technické údaje:
 Vnútorý priemer hadice: 13,0 mm
 max. Tlak: 20,0 bar
 Pripájací závit: 3/8"

515.3445

i **1**
Ďalšie informácie

od
11,90

	↔		
A	500.8040	480 mm	11,90 €
B	500.8045	1.150 mm	39,90 €

i **1**
Ďalšie informácie

1
49,90

500.8020

i **1**
Ďalšie informácie

2
59,90

500.8030

i **1**
Ďalšie informácie

**VYSOKÁ ZATAŽITEĽNOSŤ
AŽ 135 KG**

3
69,90

500.8004

i **1**
Ďalšie informácie

4
69,90

500.8011

i **1**
Ďalšie informácie

6
99,90

500.8000

	1	2	3	4	5	6
Technické údaje:	500.8020	500.8030	500.8004	500.8011	500.8090	500.8000
Farba	červený	červený	červený	červený	červený	červený
Materiál	oceľová rúra	kov	kov	kov	plast	kov
počet riadiacich koliesok	4	5	5	6	6	6
pojazdný	✓	✓	✓	✓	✓	✓
druh pneumatík	plast	plast	guma	plast	plast	plast
čalúnený	✓	✓	✓	✓	✗	✓
výškovo nastaviteľný	✗	✓	✓	✓	✗	✓
Obsah obalu	1	1	1	1	1	1
celková dĺžka L v mm	365,0 mm	370,0 mm	360,0 mm	1040,0 mm	1030,0 mm	1200,0 mm
šírka B	360,0 mm	370,0 mm	360,0 mm	490,0 mm	480,0 mm	420,0 mm
výška H	360,0 mm	420,0 - 540,0 mm	463,0 - 580,0 mm	85,0 - 400,0 mm	115,0 mm	145,0 - 510,0 mm
Celková nosnosť kg	90 kg	90 kg	135 kg	90 kg	120 kg	90 kg

i **1**
Ďalšie informácie

NAJĽAHŠIA

5
67,90

500.8090

i **3**

Ďalšie informácie

Geniálne flexibilné

1 53 x 29,5 x 3,2 cm

2 25,5 x 23,3 x 2,4 cm

3 27,5 x 14,5 x 2,4 cm

NOVINKA

44,90

500.8077 Súprava úložného priestoru na náradie zo silikónu

i **1**

Ďalšie informácie

- s protišmykovým profilom na plošine
- s veľkou plošinou na bezpečné státie
- plastové hrany na nohách chránia plošinu a podlahu

99,90

800.0960 Hliníková bezpečnostná plošina

TESTOVANÉ PRE VAŠU BEZPEČNOSŤ!

i **1**

Ďalšie informácie

- s profilom ryhovaného plechu na stupienkoch
- žiadne preklopenie vďaka šikmo umiestneným stojanovým nohám
- sklápatelné a v dôsledku toho skladovateľné s úsporou miesta

54,90

800.0965 Hliníkový dvojitý rebrík, schodíkový





1
Ďalšie informácie

MAXIMÁLNY PRACOVNÝ PRIESTOR

1199,⁹⁰



865.0201

XXL dielenský pracovný stôl s 3 zásuvkami a 1 dverami





1
Ďalšie informácie

MALÉ A VELKÉ ZÁROVEŇ!



500.8100

Univerzálny, viacúčelový teleskopický vozík s kolieskami





1
Ďalšie informácie



Ø 440 mm

3 5000 rpm, 57 dB, 4,9 m/s, 56,9 W

2 4500 rpm, 51,5 dB, 4,3 m/s, 53 W

1 4000 rpm, 48 dB, 3,5 m/s, 49 W



EXTRÉMNE TICHÝ
ULTRALAHKÝ
< 3,5 KG

999.2000

Dielenský ventilátor, 70 wattov





1
Ďalšie informácie



360°
s otočným tanierom

Paralelný zverák

od 165,⁹⁰

indukčne kalené
čeluste a kovadlina



914.0004	120 mm	4"	165, ⁹⁰ €
914.0005	140 mm	5"	178, ⁹⁰ €
914.0006	160 mm	6"	189, ⁹⁰ €
914.0008	200 mm	8"	229, ⁹⁰ €

i

1

Ďalšie informácie

max. 8 bar
(116 PSI)

60° C
140° F

19,90

1

 Water
Max. 40° C
Max.

2

 Detergent

3

4

5

Switch

Lock

150.8271 **Tlakový čerpací rozprašovač peny (penič)**

i

1

Ďalšie informácie

84,90

500.8013 **Pojadný stolček**

i

1

Ďalšie informácie

6,3 bar

96 L/min

92 dbA

1/4" PT

39,90

145 mm

3/8" - Ø 10 mm

nasávanie

fúkание

515.5090 **Pneumatická nasávací a fúkačiací pištoľ**

i **1**
 Ďalšie informácie

Ø 90 mm

M8

15 mm

5,90

515.1243 Vymazávač fólie

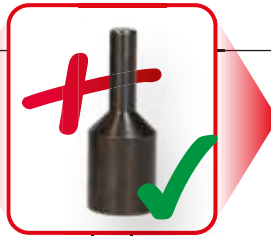

i **1**
 Ďalšie informácie

24 mm

Ø 100 mm

M8

15,90

515.1247 Vymazávač fólie s lamelami

i **6**
 Ďalšie informácie

CENA SÚPRAVY = 6x

29,90

515.1285

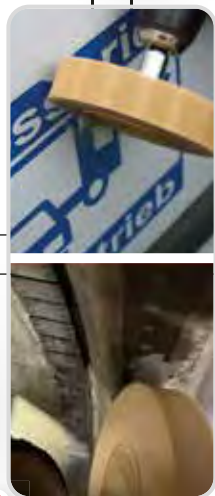

i **6**
 Ďalšie informácie

CENA SÚPRAVY = 6x

89,90

515.1366

i **1**
 Ďalšie informácie

515.1980*

ON - OFF

regulovateľný

Industrijski kroglični tečaj

141,90

515.1980 Pneumatická čistiaca pištoľ

		<3.90 m/s"/>

VOLITELNÉ

i **1**
 Ďalšie informácie

5,90

515.1983 Kefový nadstavec

i **1**
 Ďalšie informácie

5,90

515.1986 Čistiaci štetec

i **6**
Ďalšie informácie

29,90

510 mm

4 mm
8 mm
10 mm

4 mm
8 mm
10 mm

245 mm

140.2370 Súprava na uvoľňovanie svoriek

i **11**
Ďalšie informácie

19,90

180 mm 200 mm 200 mm 200 mm 210 mm

160 mm 200 mm 200 mm 180 mm 200 mm 200 mm

911.8205 Súprava plastových klinov

i **1**
Ďalšie informácie

- odstraňuje zápachy a dezinfikuje vnútorný priestor vozidla
- automatické vypnutie v režime odstraňovania zápachu po 60 minútach
- pracuje bez chemických prísad, čo zaručuje čistenie bez zvyškov
- nezanecháva žiadne stopy ani na citlivých povrchoch
- odstraňuje plesneň, baktérie, huby a roztoče

173 mm

49 mm

122 mm

79,90

550.1183 Plazmový vzduchový čistič s ionizátorom

i **1**
Ďalšie informácie

- ideálne na čistenie úzkych potrubí, hadíc alebo odtokov
- obojstranne použiteľný
- flexibilný driek z nehrdzavejúcej ocele
- nylonové štetiny

3,90 **NOVINKA**

Ø 16 mm

Ø 22 mm

150.1762 Flexibilná čistiacia kefa

i **7**
Ďalšie informácie

Ø 0 - 38 mm

Ø 0 - 48,5 mm

Ø 0 - 65 mm

Ø 0 - 30 mm

Ø 0 - 45 mm

Ø 0 - 45 mm

Ø 0 - 60 mm

79,90

115.1055 Súprava klieští na hadicové spoje na motor. vozidlá

i **3**
 Ďalšie informácie

9,90

Ø 15 mm Ø 30 mm Ø 60 mm

150 mm 180 mm 250 mm

115.5050

i **3**
 Ďalšie informácie

Ø 15 mm Ø 35 mm Ø 23 mm

155 mm 255 mm 165 mm

12,90

115.5055

i **1**
 Ďalšie informácie

14,90

Ručná pumpa na odsávanie a plnenie

150.9221

i **1**
 Ďalšie informácie

19,90

100 mm

3/8" špeciálny nástrčkový kľúč pre skrutkové spoje sacích potrubí

150.2519

i **1**
 Ďalšie informácie

19,90

12V 5A 60W
 Richtung Direction
 150.2620

PETROL DIESEL OIL

Elektrické čerpadlo na odsávanie a plnenie oleja

150.2620

i **1**
 Ďalšie informácie

Výmenný orech pre hadicové spony 30-45 mm a 60-80 mm

4,90

NOVINKA

30 mm

Špeciálny nástrčkový kľúč 2v1 na hadicové spony s 3-bodovým profilom

115.0915

i **1**
 Ďalšie informácie

12,90

NOVINKA

1/2"

108 mm

Nástroj na uvoľnenie krytu chladiča pre VAG

150.1919

i  **25**
 Další informace



0 - 2,5 bar



max. 76 cm



0 - 200 °C
0 - 400 °F

1600 mm



R123
R124

R123
R125

#1

#2

#3

M50 x 2,5

M42 x 3



M58 x 3

M62 x 3

M48 x 4

M45 x 3

M50 x 2,5

M60 x 4

M52 x 3



M48 x 2,5

M42 x 2,5

M50 x 3

M46 x 3

M34 x 2,5

75 mm

179,90



Servisná súprava

na diagnostiku chladiaceho systému

150.1930

i  **1**
 Další informace

Spojka 7,2 mm na 4,4 mm



7,2 mm

80 mm

4,4 mm



19,90

150.1936

i  **1**
 Další informace

Spojka 4,4 mm na 7,2 mm



4,4 mm

74 mm

7,2 mm



24,90

150.1937

i  **8**
 Další informace

250 ml

99,90

VOLITELNÉ

14,90

150.1910 Súprava na testovanie netesnosti hlavy valcov pomocou CO2

150.1914



i  **3**
 Další informace

GENIÁLNE FLEXIBILNÉ

53 x 29,5 x 3,2 cm

1

2

3

25,5 x 23,3 x 2,4 cm

27,5 x 14,5 x 2,4 cm

NOVINKA

44,90

500.8077 Súprava úložného priestoru na náradie zo silikónu





EcoBoost

24,90



14 mm

180 mm

16 mm

215 mm

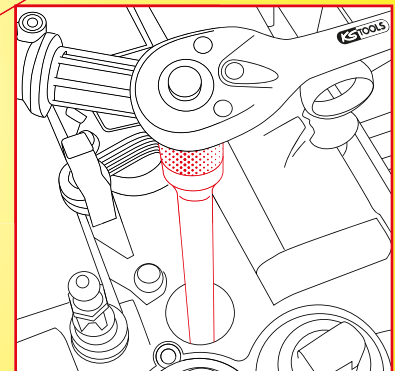

PRE MOTORY FORD ECOBOOST 1,0 L

PRE MOTORY FORD ECOBOOST 1,5 L

517.1135



Súprava nástrčných orechov pre zapalovacie sviečky pre motory EcoBoost



Ďalšie informácie

- na dodatočné vyrezávanie zhrdzavených a poškodených závitov sond
- ideálne pre snímače NOX a snímače filtrov pevných častíc na výfukových sústavách
- so 6 reznými hranami pre ideálne centrovanie
- mimoriadne krátke vyhotovenie
- s čistiacimi drážkami vo vodiacom čape

27 mm

M20 x 1.5

M22 x 1.5



13 mm

so 6 reznými hranami pre ideálne centrovanie

s čistiacimi drážkami vo vodiacom čape

179,90

150.2540

Súprava závitorezov s vodiacim čapom pre snímače

GENIÁLNE NÁRADIE NA RIEŠENIE PROBLÉMOV

NOVINKA



Ďalšie informácie

Závitorez s vodiacim čapom

- na dodatočné vyrezávanie zhrdzavených a poškodených závitov sond



13 mm

so 6 reznými hranami pre ideálne centrovanie

s čistiacimi drážkami vo vodiacom čape



99,90

			L1	L2	Hex		
A	150.2541	pre teplotné senzory	M12 x 1,25	55 mm	33 mm	13 mm	99,90 €
B	150.2542	pre teplotné senzory	M14 x 1,5	45 mm	30 mm	13 mm	99,90 €
C	150.2543	pre lambda sondy	M18 x 1,5	42 mm	27 mm	13 mm	99,90 €
D	150.2544	pre senzory NOX	M20 x 1,5	50 mm	27 mm	13 mm	99,90 €
E	150.2546	pre senzory filtrov pevných častíc	M22 x 1,5	50 mm	27 mm	13 mm	99,90 €

i  **1**
 Další informace

19,90



1 **2**

500.7505 **Sťahovák zapalovacích cievok pre tyčové zapalovacie sviečky**



i  **7**
 Další informace

PRE MOTORY VAG A OPEL

69,90



1 **2** **3** **4**
5 **6** **7**

500.7570 **Súprava sťahovákov zapalovacích cievok s T-rukoväťou pre motory VAG a Opel**



i  **7**
 Další informace

120 ml 120 ml



6x10
6x6
6x8
6x4
600 mm
Ø 6x9 mm

169,90

150.1900 **Súprava tlakových a podtlakových púmp**



i  **24**
 Další informace



49,90

700.1280 **Súprava montážneho náradia pre univerzálny tesniaci krúžok na hriadeľi a Simmeringový krúžok**



i **1**
Ďalšie informácie

39,90

150.3170 **Univerzálny sťahovák ryhovanej remenice Ø 40-165 mm**

i **1**
Ďalšie informácie

NOVINKA

- na upínanie a uvoľňovanie napínacej kladky ozubeného remeňa
- nastaviteľný, univerzálne použiteľný
- vnútorný štvorhran podľa DIN 3120 / ISO 1174
- s pohonom s vonkajším šesťhranom 13,0 mm
- fosfátovaný

19,90

150.3046 **Univerzálny čapový kľúč pre napínanie kladku ozubeného remeňa, nastaviteľný**

i **1**
Ďalšie informácie

Oblasti použitia: Citroën, Peugeot, Opel a Toyotas benzínovými motormi 1,0 a 1,2 (kód motora: ZMZ (EB0F / EBO) / HM01 (1PP) / HMV, HMZ (EB2) / HMZ (EB2 / EB2F) / HMT (EB2D) / HMU (EB2D) / HNZ (EB2DT) / HNY (EB2DTS) / HMV (EB2M) / HMY (EB2M) / B12XE (EB2F) / D12XE (EB2FA) / B12XHL (EB2DT) / D12XHL, F12XHL (EB2ADT) / B12XHT (EB2DTS) / D12XHT, F12XHT (EB2ADTS)

9,90

400.2118 **Skúšobné náradie na ozubený remeň pre PSA**

i **1**
Ďalšie informácie

34,90

150.3130 **Univerzálny sťahovák na remenice 3-ramenný**

i **22**
Ďalšie informácie

- na montáž a demontáž ťažko otvárateľných spojok vedení s pružinovým uzáverom CLIC pri palivových vedeniach, vedeniach klimatizácií, vzduchových a hydraulických vedeniach.
- žiadne poškodenie násuvných spojov, palivových vedení a palivových hadíc
- rýchle a jednoduché rezanie palivových vedení
- pre takmer všetky spojky vedení na európskych, ázijských a amerických vozidlách

115.1260 **Súprava na odblokovanie konektora linky**

49,90

5/16" 1/4" 5/16" 3/8" 3/8" 1/2" 5/8" 7/8"

3/8" 1/2" 5/8" 3/4" 5/16"

3/8" 1/2" 5/8"

3/4" 7/8" 5/16" x 3/8"

5/16"



Ďalšie informácie

S 3 873 ÚDERMI ZA MINÚTU VYTIAHNE VŠETKO!

- vrátane 7 adaptérov pre takmer všetky vstrekovače
- mimoriadne vysoký rázový účinok (3365 (6,3 bar) / 3873 (8 bar) úderov za minútu)
- na demontáž zapečených injektorov v hlave valca
- odsáva sa pomocou vhodného adaptéra priskrutkuje k tesne usadenému vstrekovaciemu hrdlu
- malá potreba miesta vďaka kompaktnej konštrukcii

NOVINKA

223 L/min	3/4" - 19 mm	108,4 dbA
6,3 bar (90 psi)	71,9 m/s ²	6 mm
12 bar	119,4 dbA	M18 x 1,5



A

B

C



D



E

F

G

H



3,873 x / min

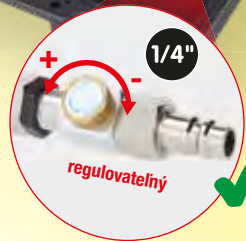

1/4"

regulovateľný

230 mm

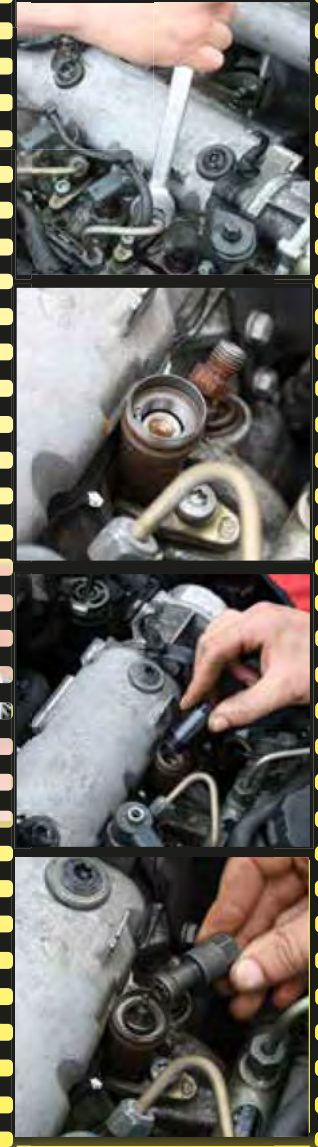

A	M25 x 1,0	Siemens
B	M20 x 1,0	Denso
C	M27 x 1,0	Siemens
D	M27/M17/ 10 mm	Bosch/Fiat/BMW/PSA/ Mercedes/Renault
E	M18 x 1,5	Adaptér
F	M17 x 1,0	Bosch/Mercedes
G	M16 x 1,0	Toyota
H	M14 x 1,5	Bosch/Delphi/BMW

BOSCH DENSO DELPHI SIEMENS



...

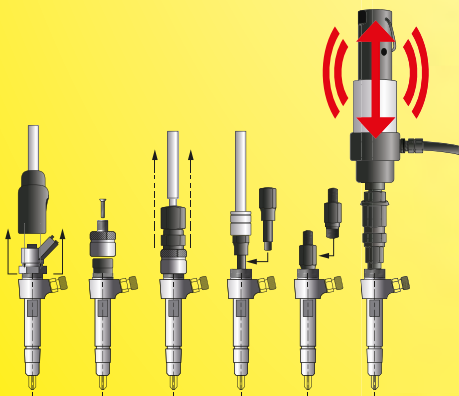

269,⁹⁰

Súprava na vyťahovanie vstrekovačov
stlačeného vzduchu

152.1130

6
 Další informace

285 - 875 mm
TELESKOPICKY VYSŮVATELNÉ
 150 - 675 mm

500g
 200g
 1000g
 2000g
 3000g

Ø 4 mm
 Ø 13 mm
 Ø 16 mm
 Ø 19 mm

400 mm
 510 mm

NOVINKA

26,90

550.1090 Flexibilný a teleskopický magnetický držák a súprava inšpekčných zrkadiel

1
 Další informace

125 mm

6 - 24 V
4,90

550.1504 Skúšobná lampa 6 - 24 V

1
 Další informace

11,90

3 - 48 V

550.1503 Skúšačka polaroty a napätia 3 - 48 V

2
 Další informace

129,90

25 m

6 - 24 V

Funkčná kontrolná lampa

150.1655

2
 Další informace

1 Prijímač
2 Vysielač s krokodílikovými svorkami

59,90

150.3075 Detektor skratu





1

Ďalšie informácie







 **Nabíjanie batérie**
 **Udržiavacie nabíjanie**
 **Oprava batérie**
 **Napájanie jednosmerným prúdom**



Prepínateľný medzi 12 a 24 V

369,⁹⁰

Teplotný senzor



Technické údaje:

Kapacita batérie:	12V: 75-500Ah - 24V: 45-250Ah
Rozsah napätia:	220-240V AC, 50/60Hz
Nabíjacie napätie:	14,4V - 25A (12V), 28,8V - 12,5A (24V)
Frekvenčné pásmo:	50 Hz
Vedenie:	H05RN-F 2x1,0 mm ²

550.1745 **12 V + 24 V SMARTcharger vysokofrekvenčná nabíjačka batérií 25 A/12,5 A**







1

Ďalšie informácie









367,⁹⁰

Takmer pre všetky batérie

S tlačiarňou a 3 kotúčmi papiera



Technické údaje:

Zobrazenie:	digitálny
Pracovná oblasť CA / MCA:	40-2.000 CCA
Pracovná oblasť CCA:	40-2.000 CCA
Pracovná oblasť DIN:	40-2.000 CCA
Pracovná oblasť EN:	40-2.000 CCA
Pracovná oblasť IEC:	40-2.000 CCA
Pracovná oblasť JIS#:	40-2.000 CCA
Pracovná oblasť SAE:	40-2.000 CCA
Pracovná teplota:	0 °C až +55 °C
Frekvenčné pásmo:	100 Hz
Meračí rozsah:	9-36 V
Presnosť merania:	+/- 0,5 Megaohm
Rozsah napätia:	9-36 V

550.1649 **12 V / 24 V Digitálny prístroj na testovanie batérií a systémů nabíjania s integrovanou tlačiarňou**





1

Ďalšie informácie















599,⁹⁰

Inteligentný bezpečnostný koncept zabráňuje chybám používateľa:

Bezpečnostný obvod privádza prúd na svorky iba vtedy, keď:

- bol správne pripojený (pólovanie)
- spojenie je odolné proti skratu
- je prítomné správne napätie
- je batéria vozidla v poriadku

550.1720 **12 V + 24 V Booster - mobilný prístroj na pomoc pri štartovaní 1400 A**

1.400 A



Ďalšie informácie



3/8"

329,⁹⁰

Súprava izolovaného náradia pre hybridy a elektromobily

117.1895

2 x		4 mm - 5,5 mm
2 x		PH1 - PH2
6 x		6 - 8 - 10 - 12 - 13 - 17 mm
1 x		185 mm
1 x		165 mm
1 x		3/8"
1 x		3/8": 200 mm
1 x		3/8": 125 mm
10 x		3/8": 8 - 10 - 11 - 12 - 13 - 14 - 16 - 17 - 19 - 22 mm
1 x		200 mm



Ďalšie informácie



3/8"

564,⁹⁰

Súprava izolovaného náradia pre hybridy a elektromobily

117.1890

4 x		2,5 - 3 - 3,5 - 4 mm
3 x		PH1 - PH2 - PH3
3 x		T20 - T25 - T30
1 x		210 mm
1 x		185 mm
1 x		165 mm
1 x		215 mm
1 x		165 mm
1 x		240 mm
2 x		10 - 25 mm
1 x		180 mm
1 x		3/8"
15 x		3/8": 6 - 7 - 8 - 9 - 10 - 11 - 12 - 13 - 14 - 16 - 17 - 18 - 19 - 20 - 22 mm
2 x		3/8": 150 - 250 mm
3 x		3/8": M8 - M10 - M12
1 x		Ø 200 mm
1 x		200 mm
1 x		500 m



Ďalšie informácie



329,⁹⁰

Súprava otvorených kľúčov s ochrannou izoláciou

118.1500

18 x		7 - 8 - 9 - 10 - 11 - 12 - 13 - 14 - 15 - 16 - 17 - 18 - 19 - 20 - 21 - 22 - 23 - 24 mm
------	--	---



Ďalšie informácie

<44.500 V



179,⁹⁰

Izolovaná záchraná tyč

150.0913



Ďalšie informácie

ZÁKLADNÁ SÚPRAVA PRE ELEKTROMOBILITU

ecoLine



1



2,5 - 4 - 5,5 mm PH0 - PH1 - PH2



2

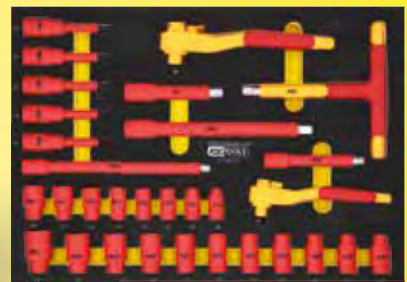

3/8" 8-18 mm 125+250 mm
1/2" 10-24 mm 125+250 mm
4-5-6-8-10 mm
3/8"+1/2"



117.0222

117.0223



Štvorcové dierovanie pre diely príslušenstva

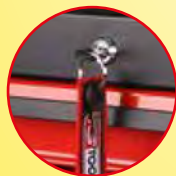

uzamykatelný cez zabudovanú vložku zámku



pracovná doska s penovou vložkou s hrúbkou 10 mm



so samočinným vtáňovaním a funkciou SOFT-CLOSE



2 x s pohyblivou a otočnou brzdou, kolesá : Ø 125 mm

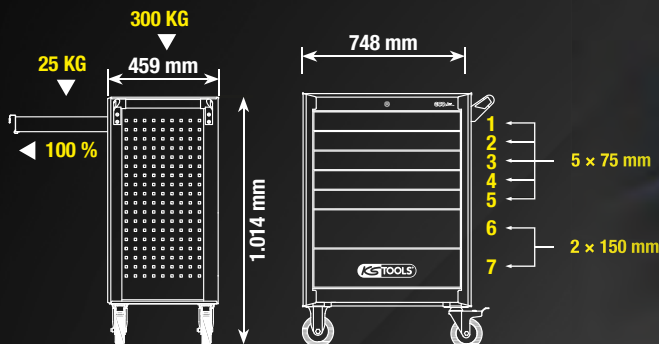

ECOline dielenský vozík so 42 kusmi izolovaného náradia pre hybridné vozidlá a elektromobily

117.6144

1299,00

VRTÁNE 42 DIELMI NÁRADIA

4299,00

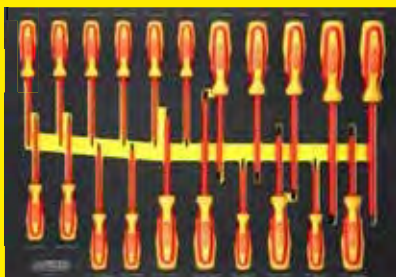

117.6155 PERFORMANCEplus dielenský vozík e10 so 164 kusmi izolovaného náradia pre hybridné vozidlá a elektromobily

NAJROZSIAHLEJŠÍ VO SVOJEJ TRIEDE



117.0223
 Stojan v tvare strechy so symbolom blesku a magnetom



9,90

117.0222

Stojan v tvare strechy so symbolom blesku a prísavkou



14,90

117.0226

Stojan so symbolom blesku

69,90

117.1550

Súprava uzatváracích stĺpikov s reťazou

2x

139,90

117.1545
2 x Nožnicová bariéra z plastu



188-stranový katalóg elektromobility nájdete na stránke www.kstools.com

i  **4**
Ďalšie informácie

Ø 22,0 - 28,0 mm

Ø 15,0 - 21,0 mm

Ø 17,0 - 25,0 mm

Súprava nástrojov na centrovanie spojky

8,90

150.2180 Ø 15,0 - 28,0 mm



i  **11**
Ďalšie informácie

150 kg

310 mm

450 mm

300 mm

394,90

160.0910 **Súprava univerzálnych držiakov pre prevodovku**



i  **3**
Ďalšie informácie

- 1 Montáž a demontáž plniaceho nástroja A
- 2 Vypustenie oleja, nízky prietok
- 3 Kontrola stavu naplnenia
- 4 Vypustenie oleja, plný prietok

24,90

9G-TRONIC

56 mm

20 mm

74,5 mm

9 mm

26,5 mm

39,5 mm

9 mm

152 mm

48 mm

150.9695



160.0910 **Súprava univerzálnych držiakov pre prevodovku**



i  **24**
Ďalšie informácie

NAJROZSIAHLEJŠÍ!

150.9261		1/8-27 NPT Ford
150.9262		BMW, Honda, Nissan etc.
150.9263		VAG
150.9264		VAG, Porsche
150.9265		M10 x 1.0 VAG, Mini Cooper
150.9267		M12 x 1.5 Mercedes
150.9268		M24 x 1.5 VAG DSG
150.9269		M22 x 1.5 VAG CVT
150.9271		M18 x 1.5 Skoda
150.9272		M30 x 1.5 VAG, Skoda
150.9273		Universal Flexible 300 mm, Honda, Hyundai, Kia, etc.
150.9274		5/16-24 (UNF) Volvo
150.9276		M18 x 1,5 Toyota / Lexus
150.9277		M8 x 1,0 Nissan / Infinity
150.9278		ATF-Adapter V.W, Passat
150.9562		Nissan Juke M12 x 1,25
150.9563		Mini Cooper M14 x 1,5
150.9564		issan M10 x 1,5
150.9566		GM M12 x 1,75
150.9567		Mercedes 725-9G
150.9102		VAG 7 DSG
150.9103		VAG 7 DSG
150.9104		VAG 7 DSG

199,90

VRÁTANE 23-DIELNEJ SÚPRAVY ADAPTÉROV

NOVINKA

150.9105 **Systém plnenia prevodového oleja s 23-dielnou súpravou adaptérov**



i  **4**
 Další informácie



111,90

Ø 30 mm

McPherson podpera pružiacej jednotky pre zdvihač prevodovky

160.0195

i  **7**
 Další informácie



6 mm

99,90

Súprava špeciálneho montážneho náradia pre tlmíč s dorazovou pružinou

150.9545





TESTOVANÉ  **PRE VAŠU BEZPEČNOSŤ!**

i  **6**
 Další informácie

univerzálne pre 90 % všetkých bežných pružín osobných motorových vozidiel a transportérov



Ø 140 - 195 mm

Ø 80 - 160 mm

ZATAŽENIE max 26000 N

- ideálne vhodný na bezpečnú montáž a demontáž pružiacich jednotiek McPherson
- potrebný na výmenu tlmíčov alebo závitových pružín
- univerzálne pre 90 % všetkých bežných pružín osobných motorových vozidiel a transportérov
- nenákladná a solídna alternatíva k bežným napínačom pružín
- vhodný aj pre kuželovité a guľové pružiny
- s certifikáciou TÜV

451,90

500.8400 Univerzálna súprava napínačov pružín

Technické údaje:	
kapacita pružiny:	2600 kg
Rozpätie max.:	355,0
pružinový tlak max.:	80,0 - 195,0 mm

TESTOVANÉ



PRE VAŠU BEZPEČNOSŤ!

i **11**
Ďalšie informácie

1/2" x 1/2", 100 Nm
Ø 30 mm

Ø 90 - 140 mm

372,90

500.8765 Súprava teleskopických strediacich napínakov pre vnútorné pružiny pre Audi a Seat

NA ROZŠÍRENIE

i **2**
Ďalšie informácie

Ø 95-110 mm

**PRE NAPINÁK PRUŽÍN
500.8755 + 500.8765**

Oblasti použitia:
Mercedestrieda E (W211 / W212), trieda C (W204), GLA (X156),
GLK (X204), Ford Focus II (MK2), BMW rad 1 (E81), Volkswagen Passat (B8 / 3G)

99,90

500.8770 Párový držiak pružiny Ø 95-110 mm

NA ROZŠÍRENIE

i **9**
Ďalšie informácie

Ø 30 mm

Ø 90 - 140 mm Ø 75 - 115 mm

338,90

500.8755 Súprava univerzálnych teleskopických strediacich napínakov pre vnútorné pružiny

WARNING - ACHTUNG - ADVARSEL
ADVERTENCIA - AVERTISSEMENT

PRE 95 % VŠETKÝCH VOZIDIEL



Ďalšie informácie

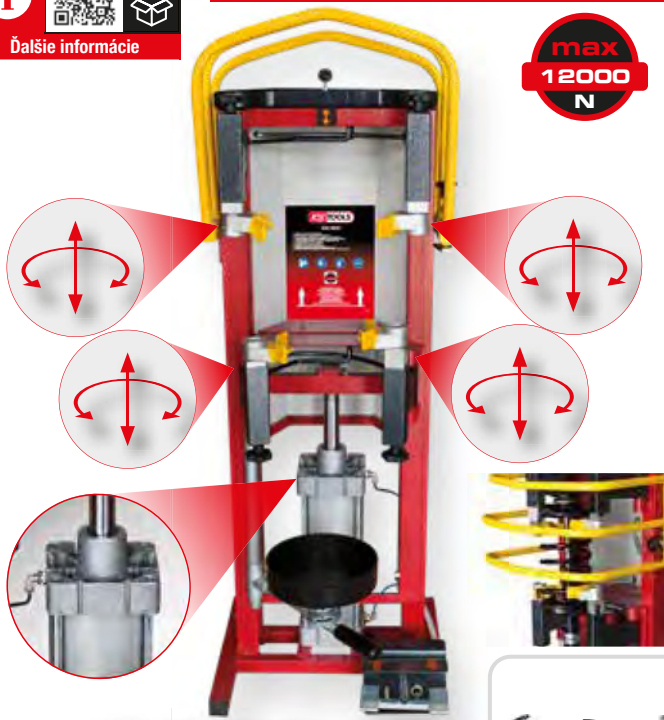

max
12000
N

1149,00

Pneumatický stojanový napínač pružín,
max. 10 bar

500.8800



Ďalšie informácie



max
24000
N

s dvojitým
valcom

1599,00

Pneumatický stojanový napínač pružín s
dvojitým valcom

500.8810

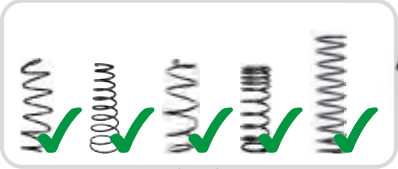

Ďalšie informácie

- jednoduchá manipulácia
- špeciálna nástrojová oceľ
- ideálny na uchytanie pružiacich jednotiek
- optimálny pre bezpečnú stabilitu pri montáži a demontáži
- so 4 fixačnými čapmi a 4 závitovými čapmi
- dodávka sa realizuje s 2 rozpernými krúžkami na montáž

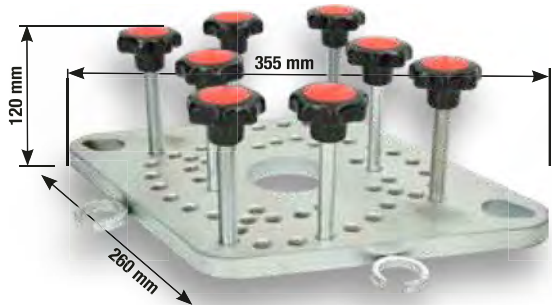

281,90



500.8801 Adaptérová doska pre pneumatický stojanový napínač pružín

SÚPRAVA NAPINÁKOV PRUŽÍN VRÁTANE ADAPTÉROVEJ DOSKY



Ďalšie informácie

Nástroj na stlačenie
vinutej pružiny v
pneumatickom stojane
vrát. dosky adaptéra



1349,00

500.8805



Ďalšie informácie

Pneumatický stojanový
napínač pružín s
dvojitým valcom vrátane
adaptérovej dosky



1799,00

500.8815

NAKONFIGURUJTE PODĽA SVOJICH PREDSTÁV

440.9051



1199,⁹⁰



VÄČŠÍ
NEŽ
SA
ZDÁ

BRZDA



440.9087



2499,⁹⁰

SILENTBLOK



440.9025

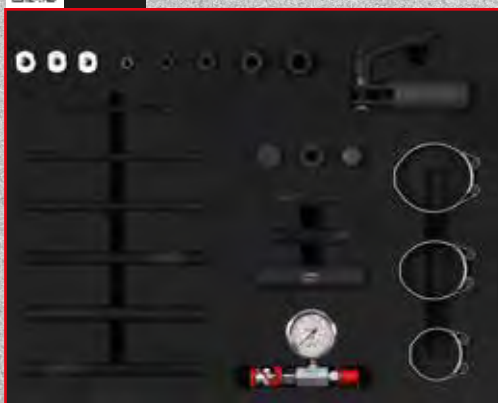

HYDRAULICKÝ VALEC BEZ OVLÁDACIEHO NÁRADIA

440.9161



3399,⁹⁰

KOMPAKTNÉ KOLESOVÉ LOŽISKO



440.9026



NÁPRAVA



MUSÍ BYŤ

MODULO 2



2760,50

PERFORMANCEplus P40 ČIERNY/ČERVENÝ
dielenský vozík so 4 zásuvkami

BEZ NÁRADIA



899,90

Súprava hydraulických čerpadiel s
odkladacím priestorom pre P40

999,90



440.9076



KOLESOVÉ LOŽISKO

1999,90

799,90



440.9061



TLMIČ

1899,90

i   **1**
Ďalšie informácie

99,⁹⁰

max. 8 bar

450 mm

1/4" PT

pre univerzálne nápravové manžety

515.3100 Pneumatický montážny prístroj pre nápravové manžety



i   **1**
Ďalšie informácie

100 mm

255 mm

Ø 30 mm

49,⁹⁰

150.1850 Univerzálny odťahovač kĺbových hriadeľov



i   **1**
Ďalšie informácie

0 - 45 mm

270 mm

39,⁹⁰

115.1056 Kliešte na hadicové spojky na uťahovanie momentom



i   **1**
Ďalšie informácie

od 25,⁹⁰

sťahovacie a viazacie pásky z ušľachtilej ocele s guľatým uzáverom
 200 - 350 mm

115.1591		 100	4,6 × 200 mm	25, ⁹⁰ €
115.1592		 100	4,6 × 250 mm	25, ⁹⁰ €
115.1593		 100	4,6 × 350 mm	28, ⁹⁰ €
115.1594		 100	4,6 × 500 mm	37, ⁹⁰ €

max. 12 mm

49,⁹⁰

115.1590 Klieština pre sťahovacie a viazacie pásky z ušľachtilej ocele s guľatým uzáverom



i   **1**
Ďalšie informácie

UNIVERSAL

10 mm

39,⁹⁰

700.5662 Rozpínacie náradie pre upínací otvor







1

Ďalšie informácie



24,⁹⁰







1/2"
30 mm

Špeciálny nástrčný orech pre nosný kĺb Mercedes

150.1721
Mercedes W167, W205, W213, W238, W253, W25





6

Ďalšie informácie

369,⁹⁰





110 mm



110 mm



130 mm



100 x 25 x 12 mm



KITOOLS VIBRO-POWER 515.3881
152880316



31x / sec.





515.3880 Súprava pneumatického kladiva Vibro-Impact





3

Ďalšie informácie



10 mm

31,⁹⁰

Súprava vyrážačov zvieracích skrutiek

700.5635





1

Ďalšie informácie

159,⁹⁰



27 mm

- uvolnenie spojovacej tyče podporované vibráciami, protichodných skrutkových spojov alebo skrutkových spojov v oblasti nápravy atď.
- Špeciálny vibračný trň aplikuje nárazový impulz na skrutkový spoj, čím sa uvoľní hrdzavenie a podporí proces uvoľňovania
- adaptér pneumatického sekáča (10 mm) pre použitie s bežnými pneumatickými sekáčovými kladivami



290 mm



10 mm



65 mm

150.1608

Pneumatický sekáč, nástroj na uvoľnenie spojovacej tyče



Ďalšie informácie



168,⁹⁰

700.1495 Univerzálna páka nápravy s reťazou



- vďaka flexibilnej reťazi je možné priečne závesné ramená najrozličnejších konštrukcií bezpečne stlačiť bez vynaloženia veľkej sily



Ďalšie informácie

121,⁹⁰

- stabilné lichobežníkové závitové vreteno
- nožný pedál na jemné nastavenie (20 mm)
- ideálny pomocník do autodiely pre rôzne situácie



160.0342 Teleskopická podpera



Ďalšie informácie



89,⁹⁰

911.8187 Teleskopická montážna páka s hlavou a kĺbom



Ďalšie informácie

99,⁹⁰



700.1465 Prístroj na preverenie vôle nápravy



Ďalšie informácie

S RÝCHLYM ZAISTENÍM



1000 W

451,⁹⁰

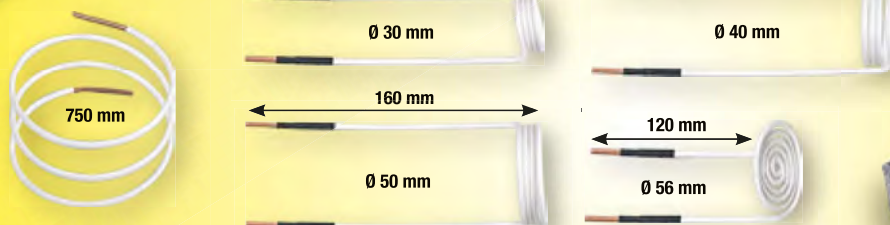

500.8605 Súprava indukčných teplovzdušných pištolí



VOLITELNÉ

129,⁹⁰

500.8440

2. GENERÁCIA - 2. GENERÁCIA - 2. GENERÁCIA



Ďalšie informácie

NOVINKA **14,⁹⁰**

HOTOVO!

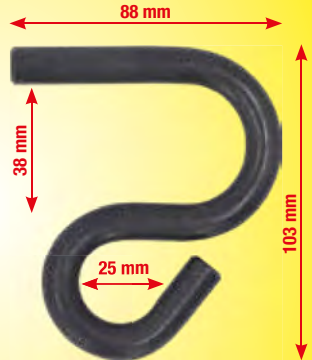
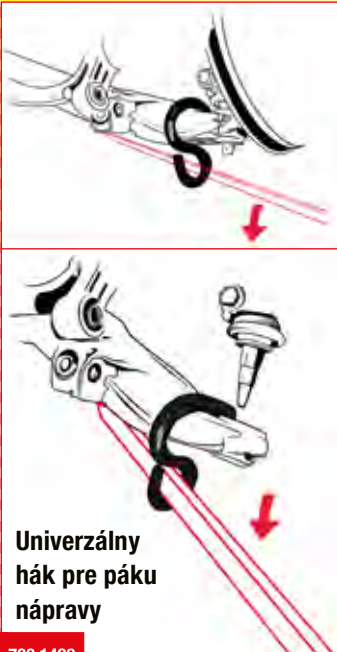

špeciálny tvar umožňuje veľmi blízke priloženie k nosnému kĺbu

špeciálna páka na odbornú a šetrnú montáž a demontáž častí nápravy

Univerzálny hák pre páku nápravy

700.1499



Ďalšie informácie

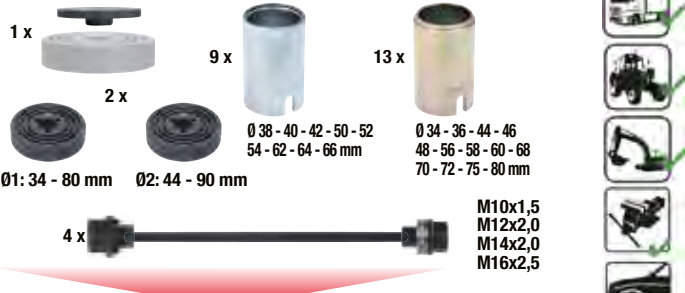

299,⁹⁰

700.1550 Súprava tlakových a ťahových puzdiel



i **22**
 Ďalšie informácie

42 40 38 36 34
 32 30 28 26 24 #1
 #2
 #3
 #4

M12
 M10
 M12 M10 TR20

Súprava stupňovitých oporných puzdier

700.2355

499,90

i **4**
 Ďalšie informácie

79,90

30-35 mm 35-40 mm 40-45 mm

360 mm

1/2" / 32 mm

Súprava špeciálnych kľúčov pre spojovaciu tyč/axiálny kĺb

150.1125

i **2**
 Ďalšie informácie

M12

NOVINKA

115 mm
 72 mm

19,90

Súprava špeciálnych silových nástrčných bitov pre skrutky s tisíchrannom (XZN®)

515.0595 1/2"

i **30**
 Ďalšie informácie

4,3 Kg

1 x \emptyset 90 - 130 mm

1 x

4 x M 14

4 x M12 x 1,25
 M12 x 1,5

4 x M12 x 1,25
 M12 x 1,5
 M14 x 1,5

1 x M18 x 2,5 x 230 mm

M57 x 2

224,90

700.1530 **Univerzálna súprava sťahovákov na náboje kolies a kĺbových hriadeľov**

MENEJ PRACOVNEJ SÍLY, VIAC ÚŽITKU.

ODDEĽTE SKLO BEZ POMOCNÍKOV!

140.2630

Univerzálny prístroj na vyrezávanie čelného skla jedným pracovníkom

- ideálne na profesionálne a šetrné odstránenie lepených čelných skiel a väčšiny zadných a bočných skiel
- s veľkou vodiacou kladkou, čo si vyžaduje menej úsilia a minimalizuje riziko pretrhnutia drôtu
- vedenie drôtu priamo pred čelným sklom, čo vo väčšine prípadov eliminuje časovo náročnú demontáž ozdobných dielov
- jednoduchá obsluha jednou osobou
- obzvlášť kvalitné prísavky pre bezpečné uchytenie na okno



13

Ďalšie informácie



ONE MAN CUT

Súprava profesionálnych ochranných panelov, 4-dielna

2x 270x200 mm + 2x 450x300 mm

NOVINKA



Nylon, 50 m

Vratná kladka

Nasávací tanier Ø 50 mm

Nasávací tanier Ø 50 mm

Fixácia rezacieho drôtu

Nosnosť: 110 kg
Drôt so štvorcovým prierezom, 50 m

Odlahčovací páka

Fixácia rezacieho drôtu

Kvalitná pumpovacia prísavka

6-hranový pohon, 30 mm

Nosnosť: 110 kg

Zavádzacia sonda na rezací drôt na sklo, 290 mm

Vratná kladka

Nasávací tanier Ø 150 mm

Nosnosť: 110 kg

Ochranný panel, zahnutý

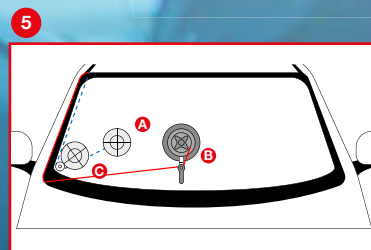
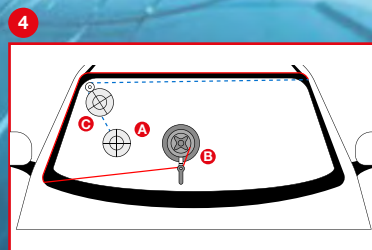
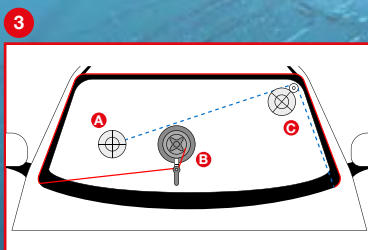
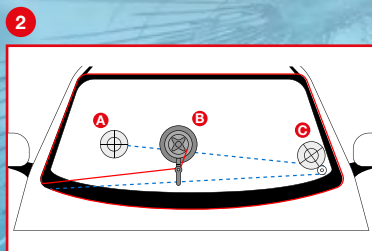
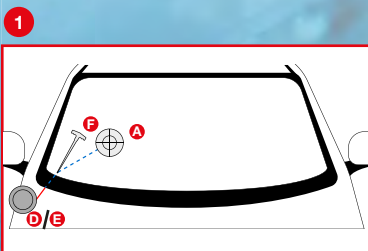

599,90

Vrátane



NOVINKA

0 20 mm

155 mm

14,90

AJ PRE DOT5.1, ENV4 A ENV6

- Dot3 ✓
- Dot4 ✓

150.1969 **Tester brzdovej kvapaliny pre DOT a ENV**

1

150.8258 **Pumpovacia rozprašovacia fľaša pre čistič brzd**

27,90

Špeciálne pre čistič brzd

2

150.1935 **Súprava univerzálnych hákov, tvarovateľné**

10,90

2

150.2235 **súprava univerzálnych hákov, tuhé**

14,90

12

150.2400 **Súprava špeciálnych nástrčných orechov pre skrutkové spoje brzdového strmeňa**

49,90

1/2" 11,5 mm 14 mm 15 mm 20 mm AS 22 mm

1/4" 9 x 20 mm

3/8" 7 x 72 mm
7 x 92 mm
9 x 50 mm
11 x 100 mm

3/8" 7 x 25 - 8 x 25 mm

41

150.1970 **Súprava nástrojov na spätné nastavenie piestov brzdového valca**

99,90

R L

Súprava nástrojov na spätné nastavenie piestov brzdového valca



Ďalšie informácie

UNIVERZÁLNY GÉNIUS



UNIVERSAL
Pre 95 % všetkých vozidiel

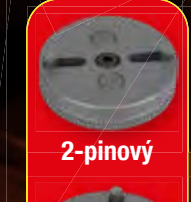

2-pinový

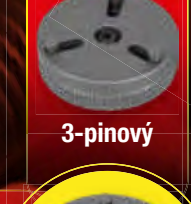

3-pinový



3/8"



4-pinový



129,90



150.2440 Univerzálne tlakové/otočné zariadenie



Ďalšie informácie

699,90



5L



160.0700 Prístroj na údržbu brzd KS5



Ďalšie informácie

49,90



min. 18 mm

univerzálne prestaviteľný



Max. 70 mm

Min. 28 mm

160.0718 Univerzálny adaptér pre odvzdušňovacie hrdlo, nastaviteľný



Ďalšie informácie

TOYOTA & LEXUS

NOVINKA

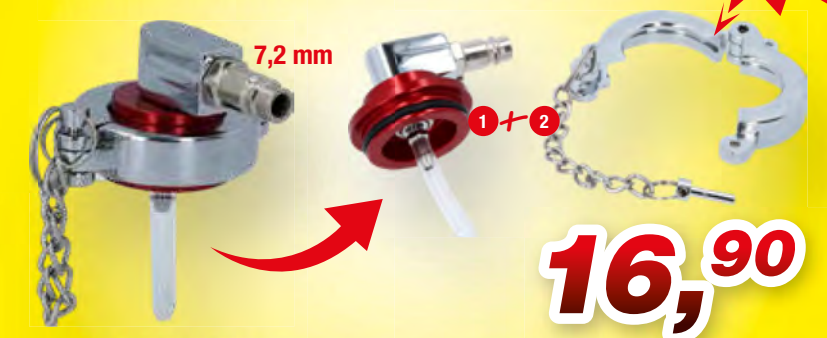

7,2 mm

1 + 2

16,90

160.0719 Univerzálny adaptér pre odvzdušňovacie hrdlo pre Toyota a Lexus

i **6**
 Ďalšie informácie

1,200 mm

STOP

69,90

11 mm
10 mm
9 mm
8 mm
7 mm

160.0725 Súprava kľúčov na odvzdušňovaciu skrutku pre brzdy

i **11**
 Ďalšie informácie

KOMPLETNÝ

1,200 mm

STOP

NOVINKA

9x12 mm 180 mm

11 mm 10 mm 11 mm 7 mm 11 mm 60 mm 70 mm 75 mm 85 mm 11 mm

12 mm 29 mm 39 mm 45 mm

74,90

518.0320 Súprava kľúčov na odvzdušňovaciu skrutku pre brzdy pre VAG

i **1**
 Ďalšie informácie

4,75 mm (3/16") 21 mm 31 mm 41 mm 61 mm 76 mm

39,90

120.1006 Ohýbacie náradie pre brzdové vedenia

i **1**
 Ďalšie informácie

4,75 mm (3/16") 6,35 mm (1/4")

29,90

1 2 3

Ohýbanie
Duplikovanie
Vyrovnávanie

120.1004 Vyrovnávacie/ohýbacie náradie na brzdové vedenia

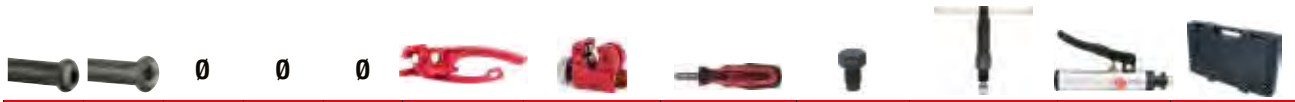

		DIN	SAE	4,75 mm	5,0 mm	6,0 mm	s ohýbačkou rúrok	s rezačkou rúrok	s odhrotovačom	mechanický	s hydraulickým vretenom	ručná pumpa	v kufri
1	122.1215	✓	✗	✓	✗	✗	✗	✗	✗	✓	✗	✗	✗
2	122.1290	✓	✓	✓	✓	✓	✓	✓	✓	✗	✓	✗	✓
3	122.1260	✓	✓	✓	✓	✓	✗	✗	✗	✗	✗	✓	✓





4

Ďalšie informácie





49,⁹⁰

1

FLAREFIXeco 4,75 mm súprava univerzálnych lemovacích prístrojov pre brzdové vedenia

122.1215





16

Ďalšie informácie

FLAREFIX



DIN

SAE

max. 2t

169,⁹⁰

2

Master súprava univerzálnych obrubovacích prístrojov

122.1290

- 4,75-5,0 mm, SAE
- 4,75 mm, 3/16"
- 6,0 mm, SAE
- 3,0-12,0 mm
- 4,75-5,0-6,0 mm, SAE-90°
- 3,0-6,0 mm
- 4,75-5,0 mm, DIN
- 3,0-16,0 mm
- 6,0 mm, DIN
- 5,0 mm
- M12x1,25
- 6,0 mm





11

Ďalšie informácie

HYDRAULICKY, PRAKTICKY, DOBRE!

FLAREFIX II

Hydraulic



max. 2,5t

DIN

SAE

299,⁹⁰

3

FLAREFIX 2 univerzálna súprava obrubovačiek na brzdové vedenia s hydraulickým valcom

122.1260

- M12 x 1,25 mm
- 4,75-5,0 mm, SAE
- 6,0 mm, SAE
- 4,75-5,0-6,0 mm, SAE-90°
- 5,0 mm
- 4,75-5,0 mm, DIN
- 4,75 mm, 3/16"
- 6,0 mm, DIN
- 6,0 mm
- M12x1,25



Ďalšie informácie



3/8"



24,90

3/8" súprava špeciálnych profilov na výmenu oleja pre plastové vypúšťacie skrutky oleja, 9 kus

150.1040



Ďalšie informácie



69,90

- nástroje na vyrovnávanie tesniaceho sedla vypúšťacích skrutiek oleja
- vyrovnanie tesniaceho sedla zaručuje bezchybné utesnenie v oblasti vypúšťacej skrutky oleja
- presné centrovanie a vyrovnanie k tesniacej ploche
- súprava vrátane prispôsobenia pre originálnu vypúšťaciu skrutku oleja a nadmerne veľkú opravnú závitovú skrutku
- v stabilnom plastovom kufríku



150.1485

Súprava rovinných fréz na vyfrézovanie tesniaceho sedla pre skrutky na vypúšťanie oleja



Ďalšie informácie



7,5 litrov

Ø 385 mm

12,90



150.9359

Zachytávacia vaňa 7,5 litrov

i  **30**
Ďalšie informácie

1/2" 21 mm
 Ø 63 - 102 mm

99,90

3/8"

65-14, 65/67-14, 66-6, 68-14, 73-14, 74-15, 74/76-15, 75/77-15, 76-8, 76-12, 76-14, 76-30, 78-15, 80-15, 80/82-15, 86-18, 86-16, 90-15, 92-10, 93-15, 93-36, 93-45, 95-15, 96-18, 100-15, 106-15, 108-15, 108-18

150.9350 **3/8" súprava kľúčov na olejový filter**



i  **24**
Ďalšie informácie

2,0 L

99,90

VW Lexus Lotus Ford Nissan
 Subaru Mitsubishi Land Rover Hyundai Audi
 Chrysler Toyota Citroën Volvo Cadillac
 Citroën Buick Volvo Buick univerzálny

150.9130 **MASTER Súprava lievnikov na plnenie oleja s otočným ramienom**



i  **4**
Ďalšie informácie

PRE VAG

s otočným uhlovým ramienom pre ťažko dostupné miesta

14,90

2,0 L

150.9155 **Súprava lievnikov na plnenie oleja s otočným ramienom pre VAG**



PRIPRAVIŤ SA - POZOR - ŠTART!

celý z gummy

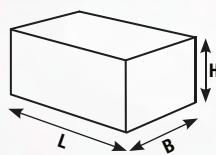

	Počet dielov	L mm	B mm	H mm	
160.0476	1	160	120	20	4, ⁹⁰ €
160.0477	1	160	120	30	6, ⁹⁰ €
160.0478	1	160	120	40	8, ⁹⁰ €
160.0479	1	160	120	60	12, ⁹⁰ €
160.0480	1	160	120	80	16, ⁹⁰ €
160.0481	1	160	120	100	20, ⁹⁰ €
160.0482	1	160	120	115	23, ⁹⁰ €
160.0483	1	116,5	116,5	36,5	5, ⁹⁰ €
160.0499	1	160	120	85	17, ⁹⁰ €

NOVINKA



Ďalšie informácie

PE (polyetylén)

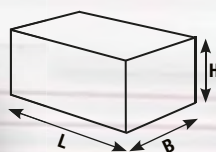
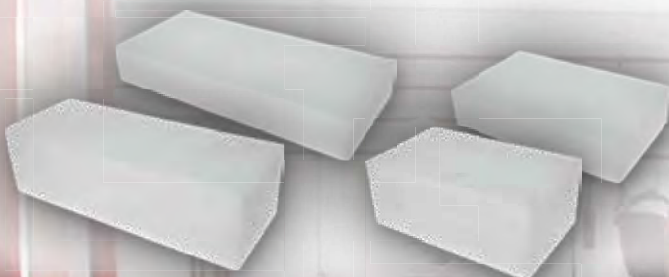

	Počet dielov	L mm	B mm	H mm	
160.0437	1	250	150	55	14, ⁹⁰ €
160.0438	1	250	150	100	26, ⁹⁰ €
160.0486	1	340	150	55	19, ⁹⁰ €
160.0489	1	340	130	100	31, ⁹⁰ €

NOVINKA



Ďalšie informácie



z plnej gummy so zosilneným jadrom



NOVINKA

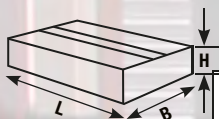

	Počet dielov	L mm	B mm	H mm	
160.0484	1	373	100	35	39, ⁹⁰ €



z plastu s vysokou pevnosťou



NOVINKA

Model 3 ✓
Model S ✓
Model X ✓
Model Y ✓



celý z gummy

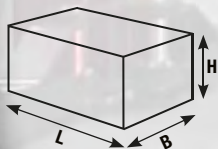

	Počet dielov	L mm	B mm	H mm	
160.0391-TD	4	155	125	35	34, ⁹⁰ €



celý z gummy



NOVINKA

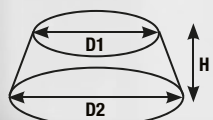

	Počet dielov	D1 mm	D2 mm	H mm	
160.0485	1	78	105	60	9, ⁹⁰ €

160.0460 Tesla Model 3, S, X, Y

23,⁹⁰



z gummy a ocelového plechu

Ďalšie informácie

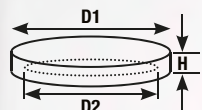

OCEĽ



	D1 mm	D2 mm	H mm	Ravaglioli	Grazia	OMCN	Intertech	MAHA	Werther	Nussbaum	AMI	Twin Bush	Sirio	Space	Launch	RP Tools	J.A. Becker	ATH	HOFMANN	Hermann		
A	160.0463	120	113	22				✓														8,90 €
B	160.0465	123	108	25	✓				✓													8,90 €
C	160.0475	120	110	19													✓	✓	✓	✓	8,90 €	



z gummy

Ďalšie informácie

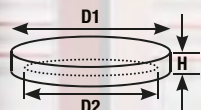

GUMA



	D1 mm	D2 mm	H mm	Ravaglioli	Grazia	OMCN	Intertech	MAHA	Werther	Nussbaum	AMI	Twin Bush	Sirio	Space	Launch	RP Tools	J.A. Becker	ATH	HOFMANN	Hermann		
A	160.0466	125	120	24						✓	✓											11,90 €
B	160.0467	140	130	25								✓										5,90 €
C	160.0468	100	85	14	✓								✓	✓								4,90 €
D	160.0464	120	113	23				✓														4,90 €
E	160.0469	120	108	32								✓			✓	✓						7,90 €
F	160.0470	130	125	14	✓								✓	✓								4,90 €
G	160.0471	140	125	30								✓										7,90 €
H	160.0472	150	130	23	✓																	6,90 €
I	160.0473	120	105	30								✓										6,90 €
J	160.0474	120	110	19													✓	✓	✓	✓		4,90 €
K	160.0490	100	80	21	✓													✓	✓	✓	✓	3,90 €
L	160.0491	120	108	26	✓	✓																4,90 €
M	160.0492	120	110	26	✓	✓																4,90 €
N	160.0493	145	108	24	✓		✓															7,90 €
O	160.0494	145	135	26	✓																	6,90 €
P	160.0495	160	135	28			✓															6,90 €
Q	160.0496	140	103	25						✓												7,90 €
R	160.0497	150	127	25	✓																	5,90 €
S	160.0498	140	132	28																		8,90 €

i  **1**
 Ďalšie informácie

7,90

Miska magnetická, z plastu, Ø 150 mm

800.0156



i  **1**
 Ďalšie informácie

9,90

Kovová ventilová páka na pneumatiky, 330 mm

150.2032



i  **1**
 Ďalšie informácie

27,90

Montážna páka na pneumatiky runflat

911.8135

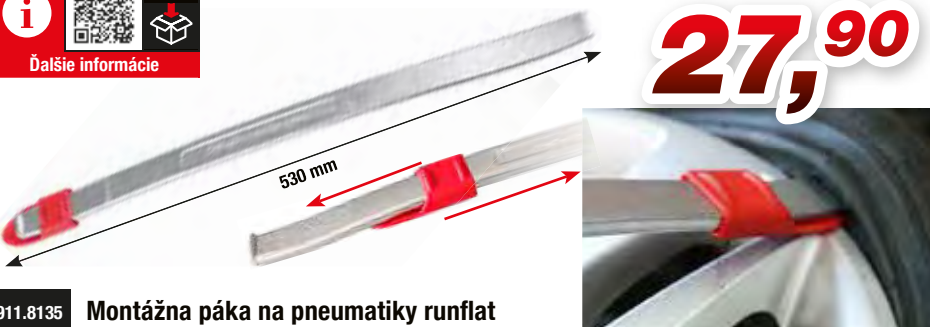

i  **1**
 Ďalšie informácie

49,90

Kovový magnetický držiak, 390 mm

800.0190



i  **1**
 Ďalšie informácie

19,90

Tlakomer na meranie tlaku v pneumatikách

515.1950

600 mm

0 - 12 bar

1/4" PT



i  **1**
 Ďalšie informácie

61,90

CIACHOVANÝ

CIACHOVANÝ tlakomer na meranie tlaku v pneumatikách

515.1960

400 mm

0 - 10 bar

1/4" PT



i  **5**
 Ďalšie informácie

56,90

Súprava na vulkanizáciu pneumatík pre vozidlá vrátane 100 mm vlákna

150.1070

70 g

9 mm

60 x 100 mm

VOLITELNÉ

60 kusov

17,90

150.1072



- 
- 
- 
- 
- 
- 
- 

i  **1**
 Další informace

89,90

Súprava hliníkovej brúsky na náboje kolesa, Ø 150 mm, vnút. Ø 90 mm

100.5080

34,90

VOLITELNÉ

100.5077

90 mm

150 mm

PREDTÝM:

POTOM:





i  **4**
 Další informace

8 mm

10 mm

8 mm

8 mm

NOVINKA

Špeciálna súprava silových nástrčných orechov na hliníkové disky pre viacdiele disk OZ

515.0795  

14,90



i  **3**
 Další informace

39,90

1/2" súprava silových nástrčných orechov so špirálovým profilom, 3-dielna

913.1270   17 - 19 - 21 mm





i  **2**
 Další informace

19,5 mm

18,5 mm

19,5

21,5

20,5

21,5 mm

20,5 mm

1/2"

Súprava špeciálnych silových nástrčných orechov pre hliníkové disky pre Ford, 18,5 / 19,5 / 20,5 / 21,5 mm

515.0895   18,5 - 19,5 - 20,5 - 21,5 mm

27,90



i  **1**
 Další informace

PRE MERCEDES

max. 75 Nm

17,90

1/2" silové torzné predĺženie, 75 Nm

515.1491 







Ďalšie informácie

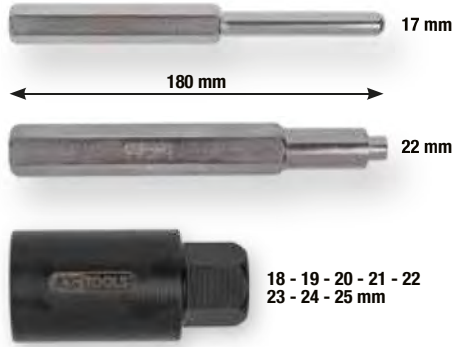

Súprava na demontáž zaistení kolies



59,90

913.1480 18 - 19 - 20 - 21 - 22 - 23 - 24 - 25 mm



Ďalšie informácie

Sprava na demontáž poistných skrutiek



139,90



UNIVERZÁLNE DÔMYSELNÉ - PRISPŮSOBIA SA KAŽDÉMU PROFILU!

913.1430



SÚPRAVA ROBUSTNÝCH 1/2" SILOVÝCH NÁSTRČNÝCH ORECHOV NA HLINÍKOVÉ DISKY

1

Ďalšie informácie

21 mm 19 mm 17 mm

17,90

515.1070 1/2" 17 - 19 - 21 mm

2

Ďalšie informácie

15 mm 17 mm 19 mm 21 mm 22 mm

24,90

515.0870 1/2" 15 - 17 - 19 - 21 - 22 mm

3

Ďalšie informácie

17 mm 15 mm 19 mm 22 mm 23 mm

21 mm 17 mm 21 mm 24 mm

1/2" 15 - 17 - 19 - 21 - 22 - 23 - 24 mm

7/8" 17 mm MS21

69,90

515.0890

4

Ďalšie informácie

15 mm 17 mm 19 mm 21 mm 22 mm 23 mm 24 mm 17 mm 21 mm

21 mm 19 mm 17 mm 18,5 mm 20,5 mm 17,5 mm

139,90

KOMPLETNÝ UNIVERZÁL

515.0885 1/2" 15 - 17 - 19 - 21 - 22 - 23 - 24 mm 7/8" 17 mm MS21 17 - 19 - 21 mm 18,5 / 19,5 - 20,5 / 21,5 - 17,5 / 22,5 mm

	515.1072 15 mm	515.1073 17 mm	515.1075 19 mm	515.1076 21 mm	515.1077 22 mm	515.1078 23 mm	515.1079 24 mm	515.1089 Tesla 7/8"	515.2055 Mercedes 17 mm	515.2060 Hyundai KIA MS21	913.1271 Spirálny orech 17 mm	913.1272 Spirálny orech 19 mm	913.1273 Spirálny orech 21 mm	515.0896 Ford 18,5 / 19,5 mm	515.0897 Ford 20,5 / 21,5 mm	515.0899 Ford 17,5 / 22,5 mm	515.1134 Silové predĺženie, 75mm
1	X	✓	✓	✓	X	X	X	X	X	X	X	X	X	X	X	X	X
2	✓	✓	✓	✓	✓	X	X	X	X	X	X	X	X	X	X	X	X
3	✓	✓	✓	✓	✓	✓	✓	✓	✓	✓	X	X	X	X	X	X	X
4	✓	✓	✓	✓	✓	✓	✓	✓	✓	✓	✓	✓	✓	✓	✓	✓	✓

i **1**
Ďalšie informácie

nabíjanie pomocou USB-C kábla (súčasť balenia)

16,90

350 Lumenov

POWER-AREA Li-Ion 800mAh

165 mm

KSTOOLS 150.44100

s laserovým ukazovateľom

LED COB Stripe inšpekčná lamp
350 lumenov s UV bodovou LED diódou a laserovým ukazovateľom

150.4400

i **1**
Ďalšie informácie

140 mm

85 Lumenov

2 x AA

14,90

25 m

perfectLight vreckové svetidlo 85 lumenov

150.4370

i **1**
Ďalšie informácie

MAX. 350 Lumenov

MAX. 100 Lumenov

270°

**MUSÍTE MAŤ!
DO DIELNE ALEBO OUTDOOR**

14,90

Li-Ion 3,7 V 1200 mAh

On/Off

Senzorový spínač

Power Display

Pohybový senzor

XPE LED 2 úrovne osvetlenia

COB LED 3 úrovne osvetlenia

Nastavenie veľkosti

95 g

8 h **4,5 h** **+** **95 g**

Modi	COB 100%	COB 40%	COB rot	XPE 100%	XPE 40%
LED	270° 3 Watt COB LED			1 Watt High Power XPE LED	
40%	350 LM	150 LM	-	100 LM	40 LM
	3 h	6 h	8 h	4 h	8 h

On/Off

17,90

Ďalšie informácie

360°

250 Lumenov

500 Lumenov

USB

1200 mAh lítium-iónová batéria (súčasť balenia)

alebo

3x AAA batérie (nie sú súčasťou balenia)

vrátane funkcie USB power banky

ON OFF

180°

20 %	●
40 %	●●
60 %	●●●
80 %	●●●●
100 %	●●●●●

150.4510

max. 3 h

3 h

IP65

19,90

Ďalšie informácie

130 Lumenov

300 Lumenov

USB-A OUT

USB-C IN

ON OFF

integrovaná lítium-iónová batéria

1.200 mAh

20 %	●
40 %	●●
60 %	●●●
80 %	●●●●
100 %	●●●●●

150.4505

max. 3 h

3 h

IP65

16,50

Ďalšie informácie

60 Lumenov

150 Lumenov

Micro USB

360°

180°

ON OFF

20 %	●
40 %	●●
60 %	●●●
80 %	●●●●
100 %	●●●●●

150.4495

max. 3,5 h

2,5 h

IP20

37,50

Ďalšie informácie

250 Lumenov

550 Lumenov

USB-A OUT

USB-C IN

ON OFF

integrovaná lítium-iónová batéria

1.200 mAh

20 %	●
40 %	●●
60 %	●●●
80 %	●●●●
100 %	●●●●●

150.4490

max. 3,5 h

3 h

IP65

i  **11**
 Další informace



20-200 Nm

1/2"

500 mm

119,90

516.2400 **1/2"** **10 - 13 - 17 - 19 - 21 - 24 mm**

125 mm

10 mm, 13 mm, 17 mm, 19 mm, 21 mm, 24 mm, 17 mm, 19 mm, 21 mm

DIN EN ISO 6799
Certifikát
 Přesnost ±1,3%

KALIBRER-KONFORMITÄTSERKLÄRUNG

THE DEVIL

1600 Nm

0 - 12 bar

2 x

Ø 150 mm

10 m

NOVINKA

119,90

515.2100

i  **8**
 Další informace

PRE VÝMĚNU PNEUMATIK V REKORDNOM ČASE

21 mm, **19 mm**, **17 mm**

1/2"

1600 Nm

2 x

Ø 150 mm

10 m

NOVINKA

119,90

515.2100

Váš partner

4 042146 956700
LL23-06SK EUR

KS Tools Werkzeuge - Maschinen GmbH
 Seligenstädter Grund 10 - 12
 D-63150 Heusenstamm
 Mail: aftersales@kstools.com
 Web: www.kstools.com
 NEMECKO

Po vyjedení tohoto prospektu strácejí všechny předcházející ceny svou platnost. Predaj len prostredníctvom špecializovaných obchodov. Tlačové chyby, omyly a technické zmeny sú vyhradené. Všetky ceny v EUR bez DPH platia do 30.9.2024.